



Schülpe

Stempel und Matrizen

passend für das Fabrikat **GEKA**



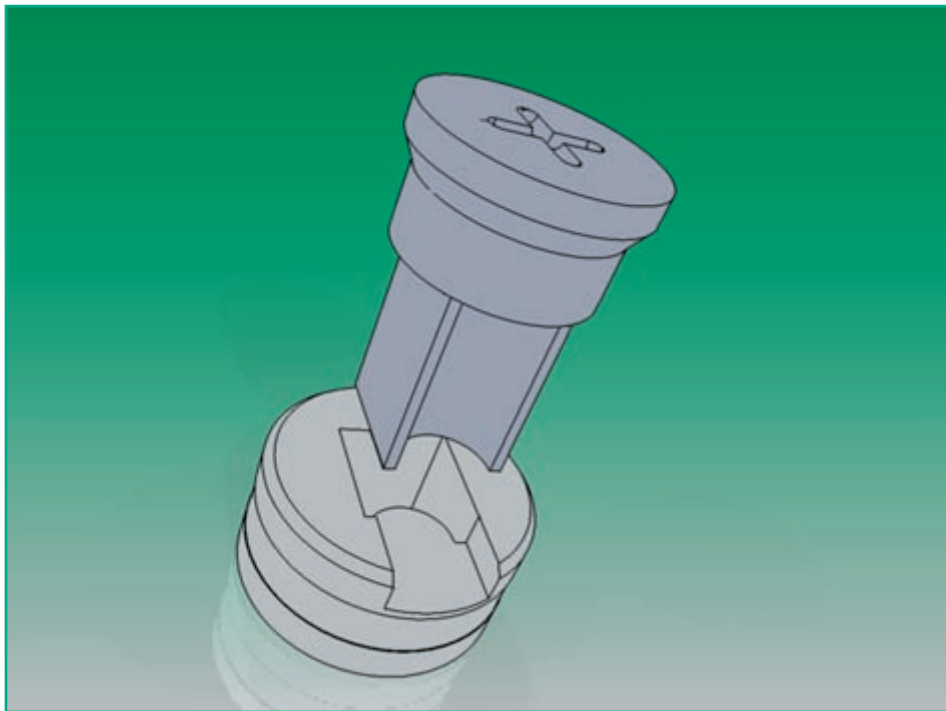
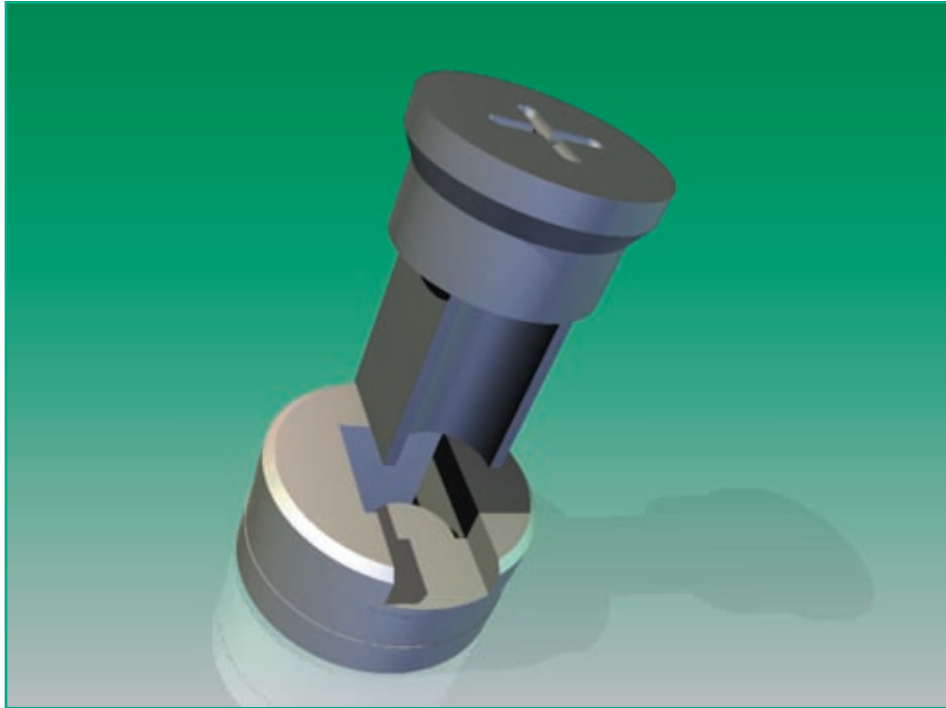

Verwendungsübersicht

Schülpe Stempel und Matrizen passend für Lochstanzen Fabrikat GEKA

Modell		Stempel		Matrizen
Multi	● ■ ● ■	1 2	● ■ ● ● ■	1 1 A 2
MICROCROP MINICROP-MULTICROP HYD-50-70 P.P.50, PUMA IW-45-45M	● ● ■ ● ■	5-15 5-27 6	● ■ ● ■	5 6
BENDICROP	● ■	8-31	● ■	5
HYD-55-80 PUMA-55-80 IW-55-80	● ■ ● ● ■ ● ■	6 8-19 8-31 8-40	● ■ ● ■	5 8
HYD-100 PUMA-100	● ● ■	8-19 8-31	● ■ ● ■	5 8
HYD-110 PUMA-110 IW-110	● ● ■ ● ■	8-19 8-31 8-40	● ■	10
HYD-150-200 PUMA-150-200	● ■ ● ■	10-26 10-40	● ■	10
MINICROP-MULTICROP HYD-50-70-100 PUMA-50-70-100 HYD-55-80-110 PUMA-55-80-110	● ■ ● ■ ● ■ ● ■ ● ■	11 12 13	● ■ ● ■ ● ■	11 12 13
HYD-150-200 PUMA-150-200 PUMA-165-220	● ■ ● ■ ● ■	11 A 12 A 13 A	● ■ ● ■ ● ■	11 12 13



Schneidspiel zwischen Stempel und Matrize

Die Größe des zu stanzenen Loches wird durch das Ist-Maß des Stempels bestimmt
Das Schneidspiel zwischen Stempel und Matrize sollte bei ca. 10 % der zu stanzenen Materialdicke liegen.

Das Ist-Maß der Matrizenöffnung ergibt sich aus dem Ist-Maß des Stempels plus dem erforderlichen Schneidspiel.

$$(\text{Schneidspiel} = 2 \times \text{Schneidspalt}).$$

Bei Bestellung ohne Angabe von Schneidspiel oder Materialstärke erfolgt die Lieferung mit 0,7 mm Schneidspiel.

Bei Angabe von Materialstärke wird folgendes Schneidspiel geliefert:

Stempelmaß	bis 5 mm	von 5 bis 22 mm	von 22 bis 39,5 mm	über 39,5 mm
Schneidspiel	0,2 mm	0,7 mm	1,2 mm	0,2 mm
Materialdicke	bis 4 mm	von 4 bis 9 mm	von 9 bis 14 mm	bis 4 mm

Die Matrizen-Signierung entspricht dem Ist-Maß der Schneidöffnung. Dadurch können Sie Matrizen mit dem jeweils exakten Schneidspiel auswählen und bestellen.

Beispiel:

Der zu stanzen Lochdurchmesser soll 25 mm betragen:

Materialdicke	bis 4 mm	von 4 bis 9 mm	von 9 bis 14 mm	von 14 bis 19 mm	von 19 bis 24 mm
Schneidspiel	0,2 mm	0,7 mm	1,2 mm	1,7 mm	2,2 mm
Matrizenöffnung	25,2 mm	25,7 mm	26,2 mm	26,7 mm	27,2 mm

Langlochmatrizen sind wahlweise mit 0,2 oder 0,7 mm Schneidspiel lieferbar.

Auf Wunsch können Matrizen mit anderem Schneidspiel gefertigt werden.
(Mehrpreis auf Anfrage)

Die im Katalog aufgeführten Abmessungen sind in Millimeter angegeben.

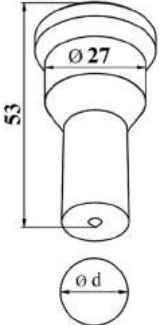
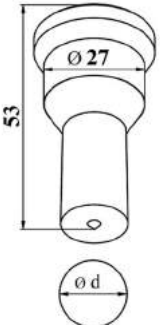
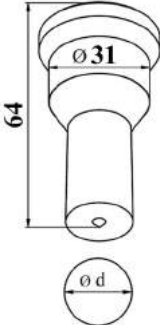
Rundstempel	Nr. 5-27	Rundstempel	Nr. 5-27	Rundstempel	Nr. 8-31
round punch		round punch		round punch	
					
d=	Best.-Nr.	d=	Best.-Nr.	d=	Best.-Nr.
3.0	G-RST527-0030	21.0	G-RST527-0210	3.0	G-RST831-0030
3.5	G-RST527-0035	21.5	G-RST527-0215	3.5	G-RST831-0035
4.0	G-RST527-0040	22.0	G-RST527-0220	4.0	G-RST831-0040
4.5	G-RST527-0045	22.5	G-RST527-0225	4.5	G-RST831-0045
5.0	G-RST527-0050	23.0	G-RST527-0230	5.0	G-RST831-0050
5.5	G-RST527-0055	23.5	G-RST527-0235	5.5	G-RST831-0055
6.0	G-RST527-0060	24.0	G-RST527-0240	6.0	G-RST831-0060
6.5	G-RST527-0065	24.5	G-RST527-0245	6.5	G-RST831-0065
7.0	G-RST527-0070	25.0	G-RST527-0250	7.0	G-RST831-0070
7.5	G-RST527-0075	25.5	G-RST527-0255	7.5	G-RST831-0075
8.0	G-RST527-0080	26.0	G-RST527-0260	8.0	G-RST831-0080
8.5	G-RST527-0085	26.5	G-RST527-0265	8.5	G-RST831-0085
9.0	G-RST527-0090	27.0	G-RST527-0270	9.0	G-RST831-0090
9.5	G-RST527-0095			9.5	G-RST831-0095
10.0	G-RST527-0100			10.0	G-RST831-0100
10.5	G-RST527-0105			10.5	G-RST831-0105
11.0	G-RST527-0110			11.0	G-RST831-0110
11.5	G-RST527-0115			11.5	G-RST831-0115
12.0	G-RST527-0120			12.0	G-RST831-0120
12.5	G-RST527-0125			12.5	G-RST831-0125
13.0	G-RST527-0130			13.0	G-RST831-0130
13.5	G-RST527-0135			13.5	G-RST831-0135
14.0	G-RST527-0140			14.0	G-RST831-0140
14.5	G-RST527-0145			14.5	G-RST831-0145
15.0	G-RST527-0150			15.0	G-RST831-0150
15.5	G-RST527-0155			15.5	G-RST831-0155
16.0	G-RST527-0160			16.0	G-RST831-0160
16.5	G-RST527-0165			16.5	G-RST831-0165
17.0	G-RST527-0170			17.0	G-RST831-0170
17.5	G-RST527-0175			17.5	G-RST831-0175
18.0	G-RST527-0180			18.0	G-RST831-0180
18.5	G-RST527-0185			18.5	G-RST831-0185
19.0	G-RST527-0190			19.0	G-RST831-0190
19.5	G-RST527-0195			19.5	G-RST831-0195
20.0	G-RST527-0200			20.0	G-RST831-0200
20.5	G-RST527-0205			20.5	G-RST831-0205

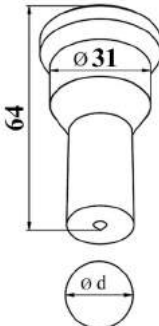
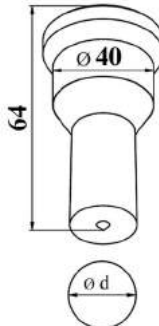
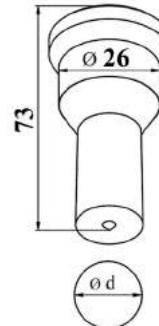
Rundstempel Nr. 8-31		Rundstempel Nr. 8-40		Rundstempel Nr. 10-26	
round punch		round punch		round punch	
					
d=	Best.-Nr.	d=	Best.-Nr.	d=	Best.-Nr.
21.0	G-RST831-0210	28.5	G-RST840-0285	3.0	G-RST1026-0030
21.5	G-RST831-0215	29.0	G-RST840-0290	3.5	G-RST1026-0035
22.0	G-RST831-0220	29.5	G-RST840-0295	4.0	G-RST1026-0040
22.5	G-RST831-0225	30.0	G-RST840-0300	4.5	G-RST1026-0045
23.0	G-RST831-0230	30.5	G-RST840-0305	5.0	G-RST1026-0050
23.5	G-RST831-0235	31.0	G-RST840-0310	5.5	G-RST1026-0055
24.0	G-RST831-0240	31.5	G-RST840-0315	6.0	G-RST1026-0060
24.5	G-RST831-0245	32.0	G-RST840-0320	6.5	G-RST1026-0065
25.0	G-RST831-0250	32.5	G-RST840-0325	7.0	G-RST1026-0070
25.5	G-RST831-0255	33.0	G-RST840-0330	7.5	G-RST1026-0075
26.0	G-RST831-0260	33.5	G-RST840-0335	8.0	G-RST1026-0080
26.5	G-RST831-0265	34.0	G-RST840-0340	8.5	G-RST1026-0085
27.0	G-RST831-0270	34.5	G-RST840-0345	9.0	G-RST1026-0090
27.5	G-RST831-0275	35.0	G-RST840-0350	9.5	G-RST1026-0095
28.0	G-RST831-0280	35.5	G-RST840-0355	10.0	G-RST1026-0100
28.5	G-RST831-0285	36.0	G-RST840-0360	10.5	G-RST1026-0105
29.0	G-RST831-0290	36.5	G-RST840-0365	11.0	G-RST1026-0110
29.5	G-RST831-0295	37.0	G-RST840-0370	11.5	G-RST1026-0115
30.0	G-RST831-0300	37.5	G-RST840-0375	12.0	G-RST1026-0120
30.5	G-RST831-0305	38.0	G-RST840-0380	12.5	G-RST1026-0125
31.0	G-RST831-0310	38.5	G-RST840-0385	13.0	G-RST1026-0130
		39.0	G-RST840-0390	13.5	G-RST1026-0135
		39.5	G-RST840-0395	14.0	G-RST1026-0140
		40.0	G-RST840-0400	14.5	G-RST1026-0145
				15.0	G-RST1026-0150
				15.5	G-RST1026-0155
				16.0	G-RST1026-0160
				16.5	G-RST1026-0165
				17.0	G-RST1026-0170
				17.5	G-RST1026-0175
				18.0	G-RST1026-0180
				18.5	G-RST1026-0185
				19.0	G-RST1026-0190
				19.5	G-RST1026-0195
				20.0	G-RST1026-0200

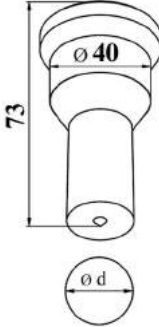
Rundstempel Nr. 10-40	
round punch	
	
d=	Best.-Nr.
20.5	G-RST1040-0205
21.0	G-RST1040-0210
21.5	G-RST1040-0215
22.0	G-RST1040-0220
22.5	G-RST1040-0225
23.0	G-RST1040-0230
23.5	G-RST1040-0235
24.0	G-RST1040-0240
24.5	G-RST1040-0245
25.0	G-RST1040-0250
25.5	G-RST1040-0255
26.0	G-RST1040-0260
26.5	G-RST1040-0265
27.0	G-RST1040-0270
27.5	G-RST1040-0275
28.0	G-RST1040-0280
28.5	G-RST1040-0285
29.0	G-RST1040-0290
29.5	G-RST1040-0295
30.0	G-RST1040-0300
30.5	G-RST1040-0305
31.0	G-RST1040-0310
31.5	G-RST1040-0315
32.0	G-RST1040-0320
32.5	G-RST1040-0325
33.0	G-RST1040-0330
33.5	G-RST1040-0335
34.0	G-RST1040-0340
34.5	G-RST1040-0345
35.0	G-RST1040-0350
35.5	G-RST1040-0355
36.0	G-RST1040-0360
36.5	G-RST1040-0365
37.0	G-RST1040-0370
37.5	G-RST1040-0375

Rundstempel Nr. 10-40	
round punch	
	
d=	Best.-Nr.
38.0	G-RST1040-0380
38.5	G-RST1040-0385
39.0	G-RST1040-0390
39.5	G-RST1040-0395
40.0	G-RST1040-0400

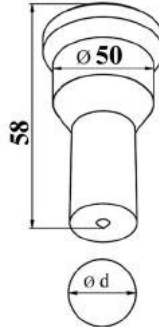
Rundstempel Nr. 11	
round punch	
	
d=	Best.-Nr.
27.5	G-RST11-0275
28.0	G-RST11-0280
28.5	G-RST11-0285
29.0	G-RST11-0290
29.5	G-RST11-0295
30.0	G-RST11-0300
30.5	G-RST11-0305
31.0	G-RST11-0310
31.5	G-RST11-0315
32.0	G-RST11-0320
32.5	G-RST11-0325
33.0	G-RST11-0330
33.5	G-RST11-0335
34.0	G-RST11-0340
34.5	G-RST11-0345
35.0	G-RST11-0350
35.5	G-RST11-0355
36.0	G-RST11-0360
36.5	G-RST11-0365
37.0	G-RST11-0370
37.5	G-RST11-0375
38.0	G-RST11-0380
38.5	G-RST11-0385
39.0	G-RST11-0390
39.5	G-RST11-0395
40.0	G-RST11-0400
40.5	G-RST11-0405
41.0	G-RST11-0410
41.5	G-RST11-0415
42.0	G-RST11-0420
42.5	G-RST11-0425
43.0	G-RST11-0430
43.5	G-RST11-0435
44.0	G-RST11-0440
44.5	G-RST11-0445
45.0	G-RST11-0450

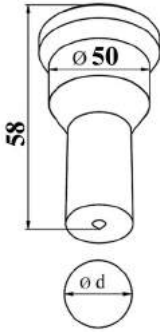
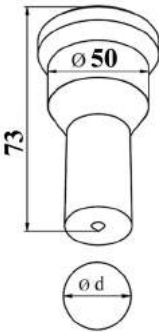
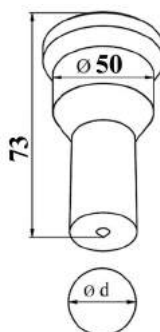
Rundstempel	Nr. 11	Rundstempel	Nr. 11 A	Rundstempel	Nr. 11 A
round punch		round punch		round punch	
					
d=	Best-Nr.	d=	Best-Nr.	d=	Best-Nr.
45.5 46.0 46.5 47.0 47.5 48.0 48.5 49.0 49.5 50.0	G-RST11-0455 G-RST11-0460 G-RST11-0465 G-RST11-0470 G-RST11-0475 G-RST11-0480 G-RST11-0485 G-RST11-0490 G-RST11-0495 G-RST11-0500	27.5 28.0 28.5 29.0 29.5 30.0 30.5 31.0 31.5 32.0 32.5 33.0 33.5 34.0 34.5 35.0 35.5 36.0 36.5 37.0 37.5 38.0 38.5 39.0 39.5 40.0 40.5 41.0 41.5 42.0 42.5 43.0 43.5 44.0 44.5 45.0 45.5	G-RST11A-0275 G-RST11A-0280 G-RST11A-0285 G-RST11A-0290 G-RST11A-0295 G-RST11A-0300 G-RST11A-0305 G-RST11A-0310 G-RST11A-0315 G-RST11A-0320 G-RST11A-0335 G-RST11A-0330 G-RST11A-0335 G-RST11A-0340 G-RST11A-0345 G-RST11A-0350 G-RST11A-0355 G-RST11A-0360 G-RST11A-0365 G-RST11A-0370 G-RST11A-0375 G-RST11A-0380 G-RST11A-0385 G-RST11A-0390 G-RST11A-0395 G-RST11A-0400 G-RST11A-0405 G-RST11A-0410 G-RST11A-0415 G-RST11A-0420 G-RST11A-0425 G-RST11A-0430 G-RST11A-0435 G-RST11A-0440 G-RST11A-0445 G-RST11A-0450 G-RST11A-0455	46.0 46.5 47.0 47.5 48.0 48.5 49.0 49.5 50.0	G-RST11A-0460 G-RST11A-0465 G-RST11A-0470 G-RST11A-0475 G-RST11A-0480 G-RST11A-0485 G-RST11A-0490 G-RST11A-0495 G-RST11A-0500

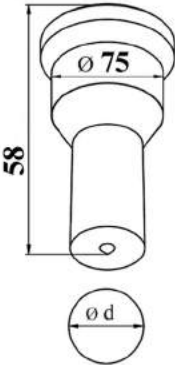
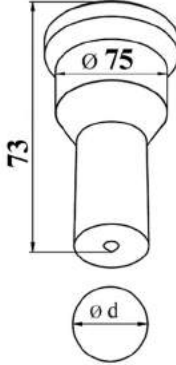
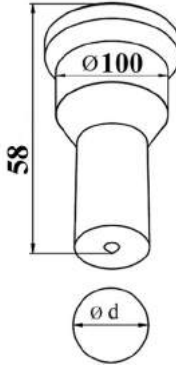
Rundstempel Nr. 12		Rundstempel Nr. 12 A		Rundstempel Nr. 13	
round punch		round punch		round punch	
					
d=	Best-Nr.	d=	Best-Nr.	d=	Best-Nr.
52.0	G-RST12-0520	52.0	G-RST12A-0520	76.0	G-RST13-0760
54.0	G-RST12-0540	54.0	G-RST12A-0540	78.0	G-RST13-0780
56.0	G-RST12-0560	56.0	G-RST12A-0560	80.0	G-RST13-0800
58.0	G-RST12-0580	58.0	G-RST12A-0580	82.0	G-RST13-0820
60.0	G-RST12-0600	60.0	G-RST12A-0600	84.0	G-RST13-0840
62.0	G-RST12-0620	62.0	G-RST12A-0620	86.0	G-RST13-0860
64.0	G-RST12-0640	64.0	G-RST12A-0640	88.0	G-RST13-0880
66.0	G-RST12-0660	66.0	G-RST12A-0660	90.0	G-RST13-0900
68.0	G-RST12-0680	68.0	G-RST12A-0680	92.0	G-RST13-0920
70.0	G-RST12-0700	70.0	G-RST12A-0700	94.0	G-RST13-0940
72.0	G-RST12-0720	72.0	G-RST12A-0720	96.0	G-RST13-0960
74.0	G-RST12-0740	74.0	G-RST12A-0740	98.0	G-RST13-0980
				100.0	G-RST13-1000

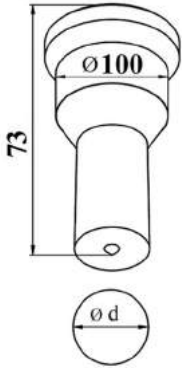
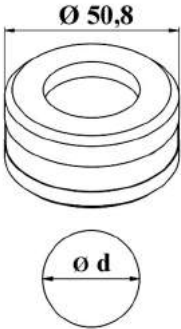
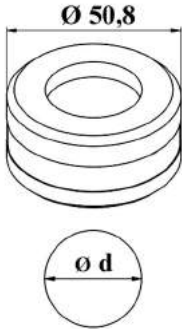
Rundstempel Nr. 13 A		Rundmatrize Nr. 5		Rundmatrize Nr. 5	
round punch		round die		round die	
					
d=	Best-Nr.	d=	Best-Nr.	d=	Best-Nr.
76.0	G-RST13A-0760	3.2	G-RMA5-0032	21.2	G-RMA5-0212
78.0	G-RST13A-0780	3.7	G-RMA5-0037	21.7	G-RMA5-0217
80.0	G-RST13A-0800	4.2	G-RMA5-0042	22.2	G-RMA5-0222
82.0	G-RST13A-0820	4.7	G-RMA5-0047	22.7	G-RMA5-0227
84.0	G-RST13A-0840	5.2	G-RMA5-0052	23.2	G-RMA5-0232
86.0	G-RST13A-0860	5.7	G-RMA5-0057	23.7	G-RMA5-0237
88.0	G-RST13A-0880	6.2	G-RMA5-0062	24.2	G-RMA5-0242
90.0	G-RST13A-0900	6.7	G-RMA5-0067	24.7	G-RMA5-0247
92.0	G-RST13A-0920	7.2	G-RMA5-0072	25.2	G-RMA5-0252
94.0	G-RST13A-0940	7.7	G-RMA5-0077	25.7	G-RMA5-0257
96.0	G-RST13A-0960	8.2	G-RMA5-0082	26.2	G-RMA5-0262
98.0	G-RST13A-0980	8.7	G-RMA5-0087	26.7	G-RMA5-0267
100.0	G-RST13A-1000	9.2	G-RMA5-0092	27.2	G-RMA5-0272
		9.7	G-RMA5-0097	27.7	G-RMA5-0277
		10.2	G-RMA5-0102	28.2	G-RMA5-0282
		10.7	G-RMA5-0107	28.7	G-RMA5-0287
		11.2	G-RMA5-0112	29.2	G-RMA5-0292
		11.7	G-RMA5-0117	29.7	G-RMA5-0297
		12.2	G-RMA5-0122	30.2	G-RMA5-0302
		12.7	G-RMA5-0127	30.7	G-RMA5-0307
		13.2	G-RMA5-0132	31.2	G-RMA5-0312
		13.7	G-RMA5-0137	31.7	G-RMA5-0317
		14.2	G-RMA5-0142	32.2	G-RMA5-0322
		14.7	G-RMA5-0147	32.7	G-RMA5-0327
		15.2	G-RMA5-0152		
		15.7	G-RMA5-0157		
		16.2	G-RMA5-0162		
		16.7	G-RMA5-0167		
		17.2	G-RMA5-0172		
		17.7	G-RMA5-0177		
		18.2	G-RMA5-0182		
		18.7	G-RMA5-0187		
		19.2	G-RMA5-0192		
		19.7	G-RMA5-0197		
		20.2	G-RMA5-0202		
		20.7	G-RMA5-0207		

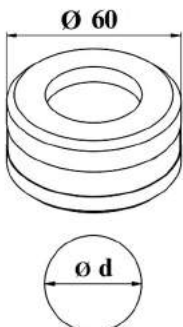
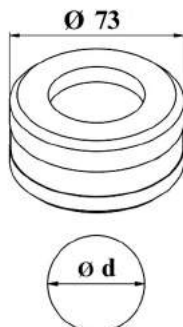
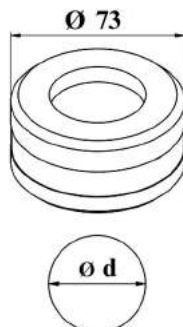
Rundmatrize Nr. 8		Rundmatrize Nr. 10		Rundmatrize Nr. 10	
round die		round die		round die	
					
d=	Best-Nr.	d=	Best-Nr.	d=	Best-Nr.
28.7	G-RMA8-0287	21.2	G-RMA10-0212	39.2	G-RMA10-0392
29.2	G-RMA8-0292	21.7	G-RMA10-0217	39.7	G-RMA10-0397
29.7	G-RMA8-0297	22.2	G-RMA10-0222	40.2	G-RMA10-0402
30.2	G-RMA8-0302	22.7	G-RMA10-0227	40.7	G-RMA10-0407
30.7	G-RMA8-0307	23.2	G-RMA10-0232	41.2	G-RMA10-0412
31.2	G-RMA8-0312	23.7	G-RMA10-0237		
31.7	G-RMA8-0317	24.2	G-RMA10-0242		
32.2	G-RMA8-0322	24.7	G-RMA10-0247		
32.7	G-RMA8-0327	25.2	G-RMA10-0252		
33.2	G-RMA8-0332	25.7	G-RMA10-0257		
33.7	G-RMA8-0337	26.2	G-RMA10-0262		
34.2	G-RMA8-0342	26.7	G-RMA10-0267		
34.7	G-RMA8-0347	27.2	G-RMA10-0272		
35.2	G-RMA8-0352	27.7	G-RMA10-0277		
35.7	G-RMA8-0357	28.2	G-RMA10-0282		
36.2	G-RMA8-0362	28.7	G-RMA10-0287		
36.7	G-RMA8-0367	29.2	G-RMA10-0292		
37.2	G-RMA8-0372	29.7	G-RMA10-0297		
37.7	G-RMA8-0377	30.2	G-RMA10-0302		
38.2	G-RMA8-0382	30.7	G-RMA10-0307		
38.7	G-RMA8-0387	31.2	G-RMA10-0312		
39.2	G-RMA8-0392	31.7	G-RMA10-0317		
39.7	G-RMA8-0397	32.2	G-RMA10-0322		
40.2	G-RMA8-0402	32.7	G-RMA10-0327		
40.7	G-RMA8-0407	33.2	G-RMA10-0332		
		33.7	G-RMA10-0337		
		34.2	G-RMA10-0342		
		34.7	G-RMA10-0347		
		35.2	G-RMA10-0352		
		35.7	G-RMA10-0357		
		36.2	G-RMA10-0362		
		36.7	G-RMA10-0367		
		37.2	G-RMA10-0372		
		37.7	G-RMA10-0377		
		38.2	G-RMA10-0382		
		38.7	G-RMA10-0387		

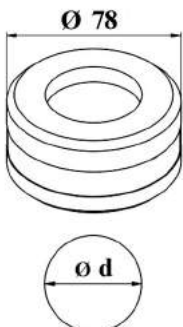
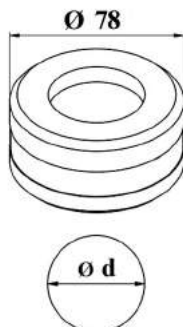
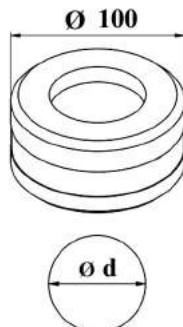
Rundmatrize Nr. 11		Rundmatrize Nr. 11		Rundmatrize Nr. 12	
round die		round die		round die	
					
d=	Best-Nr.	d=	Best-Nr.	d=	Best-Nr.
28.2	G-RMA11-0282	46.2	G-RMA11-0462	52.2	G-RMA12-0522
28.7	G-RMA11-0287	46.7	G-RMA11-0467	52.7	G-RMA12-0527
29.2	G-RMA11-0292	47.2	G-RMA11-0472	53.2	G-RMA12-0532
29.7	G-RMA11-0297	47.7	G-RMA11-0477	53.7	G-RMA12-0537
30.2	G-RMA11-0302	48.2	G-RMA11-0482	54.2	G-RMA12-0542
30.7	G-RMA11-0307	48.7	G-RMA11-0487	54.7	G-RMA12-0547
31.2	G-RMA11-0312	49.2	G-RMA11-0492	55.2	G-RMA12-0552
31.7	G-RMA11-0317	49.7	G-RMA11-0497	55.7	G-RMA12-0557
32.2	G-RMA11-0322	50.2	G-RMA11-0502	56.2	G-RMA12-0562
32.7	G-RMA11-0327	50.7	G-RMA11-0507	56.7	G-RMA12-0567
33.2	G-RMA11-0332			57.2	G-RMA12-0572
33.7	G-RMA11-0337			57.7	G-RMA12-0577
34.2	G-RMA11-0342			58.2	G-RMA12-0582
34.7	G-RMA11-0347			58.7	G-RMA12-0587
35.2	G-RMA11-0352			59.2	G-RMA12-0592
35.7	G-RMA11-0357			59.7	G-RMA12-0597
36.2	G-RMA11-0362			60.2	G-RMA12-0602
36.7	G-RMA11-0367			60.7	G-RMA12-0607
37.2	G-RMA11-0372			61.2	G-RMA12-0612
37.7	G-RMA11-0377			61.7	G-RMA12-0617
38.2	G-RMA11-0382			62.2	G-RMA12-0622
38.7	G-RMA11-0387			62.7	G-RMA12-0627
39.2	G-RMA11-0392			63.2	G-RMA12-0632
39.7	G-RMA11-0397			63.7	G-RMA12-0637
40.2	G-RMA11-0402			64.2	G-RMA12-0642
40.7	G-RMA11-0407			64.7	G-RMA12-0647
41.2	G-RMA11-0412			65.2	G-RMA12-0652
41.7	G-RMA11-0417			65.7	G-RMA12-0657
42.2	G-RMA11-0422			66.2	G-RMA12-0662
42.7	G-RMA11-0427			66.7	G-RMA12-0667
43.2	G-RMA11-0432			67.2	G-RMA12-0672
43.7	G-RMA11-0437			67.7	G-RMA12-0677
44.2	G-RMA11-0442			68.2	G-RMA12-0682
44.7	G-RMA11-0447			68.7	G-RMA12-0687
45.2	G-RMA11-0452			69.2	G-RMA12-0692
45.7	G-RMA11-0457			69.7	G-RMA12-0697

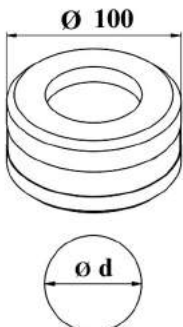
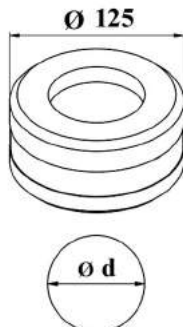
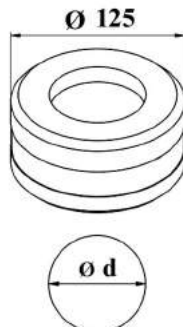
Rundmatrize Nr. 12		Rundmatrize Nr. 13		Rundmatrize Nr. 13	
round die		round die		round die	
					
d=	Best-Nr.	d=	Best-Nr.	d=	Best-Nr.
70.2	G-RMA12-0702	76.2	G-RMA13-0762	94.2	G-RMA13-0942
70.7	G-RMA12-0707	76.7	G-RMA13-0767	94.7	G-RMA13-0947
71.2	G-RMA12-0712	77.2	G-RMA13-0772	95.2	G-RMA13-0952
71.7	G-RMA12-0717	77.7	G-RMA13-0777	95.7	G-RMA13-0957
72.2	G-RMA12-0722	78.2	G-RMA13-0782	96.2	G-RMA13-0962
72.7	G-RMA12-0727	78.7	G-RMA13-0787	96.7	G-RMA13-0967
73.2	G-RMA12-0732	79.2	G-RMA13-0792	97.2	G-RMA13-0972
73.7	G-RMA12-0737	79.7	G-RMA13-0797	97.7	G-RMA13-0977
74.2	G-RMA12-0742	80.2	G-RMA13-0802	98.2	G-RMA13-0982
74.7	G-RMA12-0747	80.7	G-RMA13-0807	98.7	G-RMA13-0987
		81.2	G-RMA13-0812	99.2	G-RMA13-0992
		81.7	G-RMA13-0817	99.7	G-RMA13-0997
		82.2	G-RMA13-0822	100.2	G-RMA13-1002
		82.7	G-RMA13-0827	100.7	G-RMA13-1007
		83.2	G-RMA13-0832		
		83.7	G-RMA13-0837		
		84.2	G-RMA13-0842		
		84.7	G-RMA13-0847		
		85.2	G-RMA13-0852		
		85.7	G-RMA13-0857		
		86.2	G-RMA13-0862		
		86.7	G-RMA13-0867		
		87.2	G-RMA13-0872		
		87.7	G-RMA13-0877		
		88.2	G-RMA13-0882		
		88.7	G-RMA13-0887		
		89.2	G-RMA13-0892		
		89.7	G-RMA13-0897		
		90.2	G-RMA13-0902		
		90.7	G-RMA13-0907		
		91.2	G-RMA13-0912		
		91.7	G-RMA13-0917		
		92.2	G-RMA13-0922		
		92.7	G-RMA13-0927		
		93.2	G-RMA13-0932		
		93.7	G-RMA13-0937		

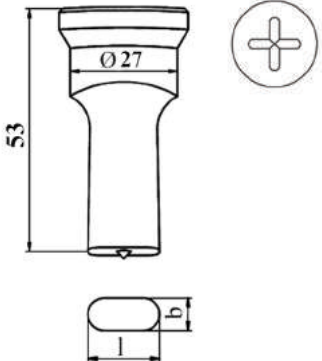
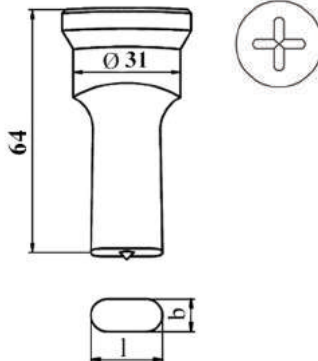
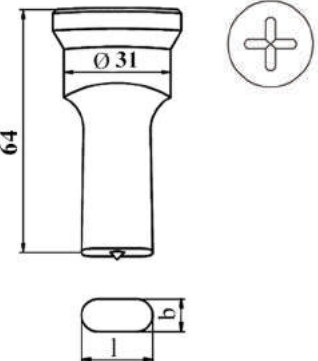
Langloch-Stempel oblong punch		Langloch-Stempel oblong punch		Langloch-Stempel oblong punch	
Nr. 5-27		Nr. 8-31		Nr. 8-31	
					
b x l	Best-Nr.	b x l	Best-Nr.	b x l	Best-Nr.
5,0 x 10,0	G-LST527-050100	5,0 x 10,0	G-LST831-050100	17,0 x 26,0	G-LST831-170260
5,0 x 14,0	G-LST527-050140	5,0 x 14,0	G-LST831-050140	18,0 x 26,0	G-LST831-180260
5,5 x 10,0	G-LST527-055100	5,5 x 10,0	G-LST831-055100	18,0 x 31,0	G-LST831-180310
5,5 x 14,0	G-LST527-055140	5,5 x 14,0	G-LST831-055140	19,0 x 26,0	G-LST831-190260
5,5 x 19,0	G-LST527-055190	5,5 x 19,0	G-LST831-055190	20,0 x 26,0	G-LST831-200260
5,5 x 25,0	G-LST527-055250	5,5 x 25,0	G-LST831-055250	20,0 x 31,0	G-LST831-200310
6,5 x 12,0	G-LST527-065120	6,5 x 12,0	G-LST831-065120	22,0 x 31,0	G-LST831-220310
6,5 x 18,0	G-LST527-065180	6,5 x 18,0	G-LST831-065180		
6,5 x 26,0	G-LST527-065260	6,5 x 26,0	G-LST831-065260	<i>Zusätzliche Abmessungen:</i>	
7,5 x 14,0	G-LST527-075140	6,5 x 30,0	G-LST831-065300	7,0 x 10,0	G-LST831-070100
7,5 x 21,0	G-LST527-075210	7,5 x 14,0	G-LST831-075140	7,0 x 15,0	G-LST831-070150
7,5 x 26,0	G-LST527-075260	7,5 x 21,0	G-LST831-075210	7,0 x 20,0	G-LST831-070200
9,0 x 14,0	G-LST527-090140	7,5 x 26,0	G-LST831-075260	9,0 x 13,0	G-LST831-090130
9,0 x 18,0	G-LST527-090180	7,5 x 30,0	G-LST831-075300	9,0 x 19,0	G-LST831-090190
9,0 x 26,0	G-LST527-090260	8,0 x 16,0	G-LST831-080160	9,0 x 25,0	G-LST831-090250
10,0 x 14,0	G-LST527-100140	9,0 x 14,0	G-LST831-090140	11,0 x 17,0	G-LST831-110170
10,0 x 20,0	G-LST527-100200	9,0 x 18,0	G-LST831-090180	11,0 x 23,0	G-LST831-110230
10,0 x 26,0	G-LST527-100260	9,0 x 26,0	G-LST831-090260	13,0 x 18,0	G-LST831-130180
11,0 x 22,0	G-LST527-110220	9,0 x 30,0	G-LST831-090300	13,0 x 22,0	G-LST831-130220
11,0 x 26,0	G-LST527-110260	10,0 x 14,0	G-LST831-100140	13,0 x 27,0	G-LST831-130270
12,0 x 24,0	G-LST527-120240	10,0 x 20,0	G-LST831-100200	13,0 x 31,0	G-LST831-130310
13,0 x 26,0	G-LST527-130260	10,0 x 26,0	G-LST831-100260	15,0 x 20,0	G-LST831-150200
14,0 x 26,0	G-LST527-140260	10,0 x 30,0	G-LST831-100300	15,0 x 24,0	G-LST831-150240
16,0 x 26,0	G-LST527-160260	11,0 x 22,0	G-LST831-110220	15,0 x 27,0	G-LST831-150270
17,0 x 26,0	G-LST527-170260	11,0 x 26,0	G-LST831-110260	17,0 x 22,0	G-LST831-170220
18,0 x 26,0	G-LST527-180260	11,0 x 30,0	G-LST831-110300	19,0 x 31,0	G-LST831-190310
19,0 x 26,0	G-LST527-190260	12,0 x 24,0	G-LST831-120240	21,0 x 27,0	G-LST831-210270
21,0 x 27,0	G-LST527-210270	12,0 x 30,0	G-LST831-120300	21,0 x 31,0	G-LST831-210310
		13,0 x 26,0	G-LST831-130260		
		13,0 x 30,0	G-LST831-130300		
		14,0 x 26,0	G-LST831-140260		
		14,0 x 31,0	G-LST831-140310		
		15,0 x 31,0	G-LST831-150310		
		16,0 x 26,0	G-LST831-160260		
		16,0 x 31,0	G-LST831-160310		

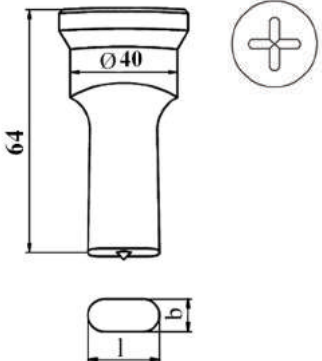
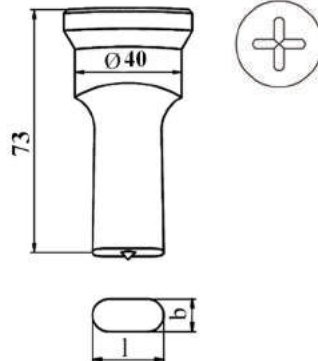
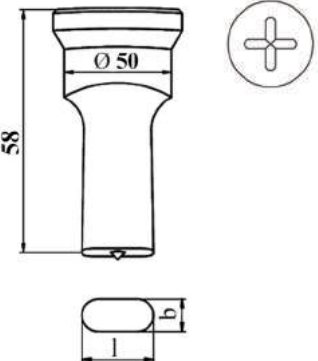
Langloch-Stempel oblong punch		Nr. 8-40		Langloch-Stempel oblong punch		Nr. 10-40		Langloch-Stempel oblong punch		Nr. 11	
											
b x l	Best-Nr.	b x l	Best-Nr.	b x l	Best-Nr.						
9,0 x 40,0	G-LST840-090400	5,5 x 25,0	G-LST1040-055250	10,0 x 30,0	G-LST11-100300						
10,0 x 40,0	G-LST840-100400	6,5 x 26,0	G-LST1040-065260	11,0 x 30,0	G-LST11-110300						
11,0 x 40,0	G-LST840-110400	6,5 x 30,0	G-LST1040-065300	12,0 x 30,0	G-LST11-120300						
13,0 x 40,0	G-LST840-130400	7,5 x 26,0	G-LST1040-075260	12,0 x 35,0	G-LST11-120350						
14,0 x 40,0	G-LST840-140400	7,5 x 30,0	G-LST1040-075300	12,0 x 40,0	G-LST11-120400						
16,0 x 40,0	G-LST840-160400	9,0 x 26,0	G-LST1040-090260	13,0 x 30,0	G-LST11-130300						
17,0 x 40,0	G-LST840-170400	9,0 x 30,0	G-LST1040-090300	13,0 x 35,0	G-LST11-130350						
18,0 x 36,0	G-LST840-180360	10,0 x 26,0	G-LST1040-100260	13,0 x 40,0	G-LST11-130400						
18,0 x 40,0	G-LST840-180400	10,0 x 30,0	G-LST1040-100300	14,0 x 28,0	G-LST11-140280						
19,0 x 40,0	G-LST840-190400	11,0 x 26,0	G-LST1040-110260	14,0 x 35,0	G-LST11-140350						
20,0 x 40,0	G-LST840-200400	11,0 x 30,0	G-LST1040-110300	14,0 x 40,0	G-LST11-140400						
22,0 x 40,0	G-LST840-220400	12,0 x 24,0	G-LST1040-120240	16,0 x 31,0	G-LST11-160310						
24,0 x 40,0	G-LST840-240400	12,0 x 30,0	G-LST1040-120300	16,0 x 40,0	G-LST11-160400						
26,0 x 40,0	G-LST840-260400	12,0 x 35,0	G-LST1040-120350	18,0 x 31,0	G-LST11-180310						
		13,0 x 26,0	G-LST1040-130260	18,0 x 40,0	G-LST11-180400						
		13,0 x 30,0	G-LST1040-130300	20,0 x 31,0	G-LST11-200310						
		13,0 x 35,0	G-LST1040-130350	20,0 x 40,0	G-LST11-200400						
		14,0 x 26,0	G-LST1040-140260	22,0 x 31,0	G-LST11-220310						
		14,0 x 28,0	G-LST1040-140280	22,0 x 40,0	G-LST11-220400						
		14,0 x 35,0	G-LST1040-140350								
		16,0 x 26,0	G-LST1040-160260								
		16,0 x 31,0	G-LST1040-160310								
		18,0 x 26,0	G-LST1040-180260								
		18,0 x 31,0	G-LST1040-180310								
		18,0 x 36,0	G-LST1040-180360								
		20,0 x 31,0	G-LST1040-200310								
		22,0 x 31,0	G-LST1040-220310								

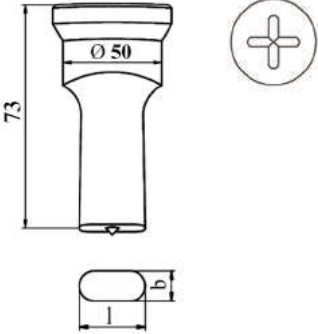
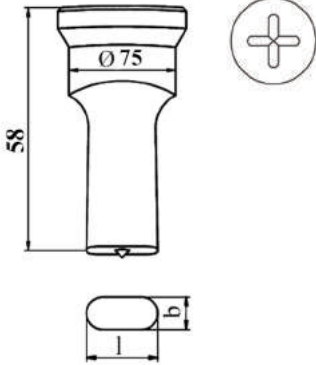
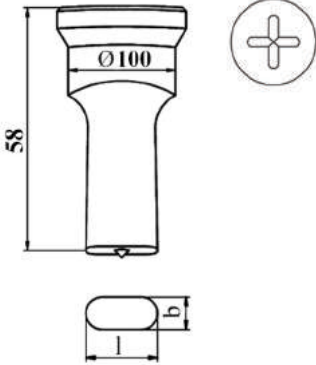
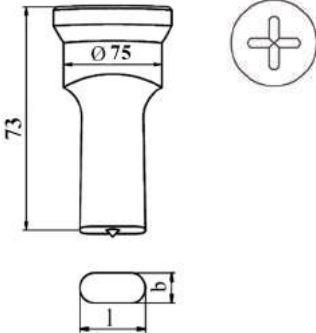
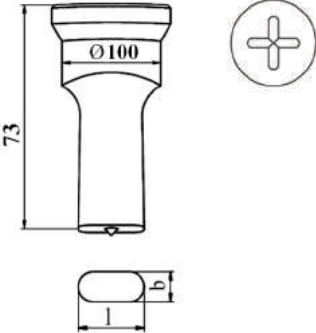
<p>Langloch-Stempel oblong punch</p>  <p>b x l Best-Nr.</p> <p>22,0 x 45,0 G-LST11A-220450 22,0 x 50,0 G-LST11A-220500</p>	<p>Langloch-Stempel oblong punch</p>  <p>b x l Best-Nr.</p> <p>16,0 x 55,0 G-LST12-160550 18,0 x 55,0 G-LST12-180550 20,0 x 55,0 G-LST12-200550 22,0 x 55,0 G-LST12-220550</p>	<p>Langloch-Stempel oblong punch</p>  <p>b x l Best-Nr.</p> <p>auf Anfrage /on application</p>
	<p>Langloch-Stempel oblong punch</p>  <p>b x l Best-Nr.</p> <p>16,0 x 55,0 G-LST12A-160550 18,0 x 55,0 G-LST12A-180550 20,0 x 55,0 G-LST12A-200550 22,0 x 55,0 G-LST12A-220550</p>	<p>Langloch-Stempel oblong punch</p>  <p>b x l Best-Nr.</p> <p>auf Anfrage /on application</p>

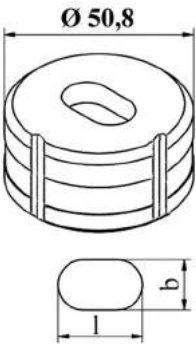
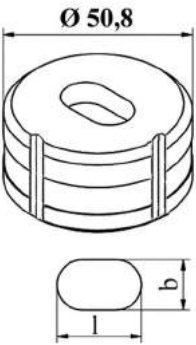
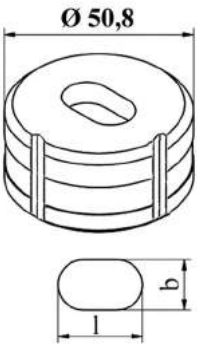
Langloch-Matrize oblong die		Nr. 5	Langloch-Matrize oblong die		Nr. 5	Langloch-Matrize oblong die		Nr. 5
								
b x l	Best-Nr.		b x l	Best-Nr.		b x l	Best-Nr.	
5,2 x 10,2	G-LMA5-052102		10,2 x 14,2	G-LMA5-102142		18,2 x 31,2	G-LMA5-182312	
5,7 x 10,7	G-LMA5-057107		10,7 x 14,7	G-LMA5-107147		18,7 x 31,7	G-LMA5-187317	
5,2 x 14,2	G-LMA5-052142		10,2 x 20,2	G-LMA5-102202		19,2 x 26,2	G-LMA5-192262	
5,7 x 14,7	G-LMA5-057147		10,7 x 20,7	G-LMA5-107207		19,7 x 26,7	G-LMA5-197267	
5,7 x 10,2	G-LMA5-057102		10,2 x 26,2	G-LMA5-102262		20,2 x 26,2	G-LMA5-202262	
6,2 x 10,7	G-LMA5-062107		10,7 x 26,7	G-LMA5-107267		20,7 x 26,7	G-LMA5-207267	
5,7 x 14,2	G-LMA5-057142		10,2 x 30,2	G-LMA5-102302		20,2 x 31,2	G-LMA5-202312	
6,2 x 14,7	G-LMA5-062147		10,7 x 30,7	G-LMA5-107307		20,7 x 31,7	G-LMA5-207317	
5,7 x 19,2	G-LMA5-057192		11,2 x 22,2	G-LMA5-112222		22,2 x 31,2	G-LMA5-227312	
6,2 x 19,7	G-LMA5-062197		11,7 x 22,7	G-LMA5-117227		22,7 x 31,7	G-LMA5-227317	
5,7 x 25,2	G-LMA5-057252		11,2 x 26,2	G-LMA5-112262				
6,2 x 25,7	G-LMA5-062257		11,7 x 26,7	G-LMA5-117267				
6,7 x 12,2	G-LMA5-067122		11,2 x 30,2	G-LMA5-112302				
7,2 x 12,7	G-LMA5-072127		11,7 x 30,7	G-LMA5-117307				
6,7 x 18,2	G-LMA5-067182		12,2 x 24,2	G-LMA5-122242		7,7 x 10,7	G-LMA5-077107	
7,2 x 18,7	G-LMA5-072187		12,7 x 24,7	G-LMA5-127247		7,7 x 15,7	G-LMA5-077157	
6,7 x 26,2	G-LMA5-067262		12,2 x 30,2	G-LMA5-122302		7,7 x 20,7	G-LMA5-077207	
7,2 x 26,7	G-LMA5-072267		12,7 x 30,7	G-LMA5-127307		8,2 x 16,2	G-LMA5-082162	
6,7 x 30,2	G-LMA5-067302		13,2 x 26,2	G-LMA5-132262		8,7 x 16,7	G-LMA5-082167	
7,2 x 30,7	G-LMA5-072307		13,7 x 26,7	G-LMA5-137267		9,7 x 13,7	G-LMA5-097137	
7,7 x 14,2	G-LMA5-077142		13,2 x 30,2	G-LMA5-132302		9,7 x 19,7	G-LMA5-097197	
8,2 x 14,7	G-LMA5-082217		13,7 x 30,7	G-LMA5-137307		9,7 x 25,7	G-LMA5-097257	
7,7 x 21,2	G-LMA5-077212		14,2 x 26,2	G-LMA5-142262		11,7 x 17,7	G-LMA5-117177	
8,2 x 21,7	G-LMA5-082217		14,7 x 26,7	G-LMA5-147267		11,7 x 23,7	G-LMA5-117237	
7,7 x 26,2	G-LMA5-077302		14,2 x 31,2	G-LMA5-142312		13,7 x 18,7	G-LMA5-137227	
8,2 x 26,7	G-LMA5-082267		14,7 x 31,7	G-LMA5-147317		13,7 x 22,7	G-LMA5-137227	
7,7 x 30,2	G-LMA5-077302		15,2 x 31,2	G-LMA5-152312		13,7 x 27,7	G-LMA5-137277	
8,2 x 30,7	G-LMA5-082307		15,7 x 31,7	G-LMA5-157317		13,7 x 31,7	G-LMA5-137317	
9,2 x 14,2	G-LMA5-092142		16,2 x 26,2	G-LMA5-162262		15,7 x 20,7	G-LMA5-157207	
9,7 x 14,7	G-LMA5-097147		16,7 x 26,7	G-LMA5-167267		15,7 x 24,7	G-LMA5-157247	
9,2 x 18,2	G-LMA5-092182		16,2 x 31,2	G-LMA5-162312		15,7 x 27,7	G-LMA5-157277	
9,7 x 18,7	G-LMA5-097187		16,7 x 31,7	G-LMA5-167317		17,7 x 22,7	G-LMA5-177227	
9,2 x 26,2	G-LMA5-092262		17,2 x 26,2	G-LMA5-172262		17,2 x 31,2	G-LMA5-172312	
9,7 x 26,7	G-LMA5-097267		17,7 x 26,7	G-LMA5-177267		17,7 x 31,7	G-LMA5-177317	
9,2 x 30,2	G-LMA5-092302		18,2 x 26,2	G-LMA5-182262		19,7 x 31,7	G-LMA5-197317	
9,7 x 30,7	G-LMA5-097307		18,7 x 26,7	G-LMA5-187267		21,2 x 27,2	G-LMA5-212272	
						21,7 x 27,7	G-LMA5-217277	

Zusätzliche Abmessungen:

7,7 x 10,7	G-LMA5-077107
7,7 x 15,7	G-LMA5-077157
7,7 x 20,7	G-LMA5-077207
8,2 x 16,2	G-LMA5-082162
8,7 x 16,7	G-LMA5-082167
9,7 x 13,7	G-LMA5-097137
9,7 x 19,7	G-LMA5-097197
9,7 x 25,7	G-LMA5-097257
11,7 x 17,7	G-LMA5-117177
11,7 x 23,7	G-LMA5-117237
13,7 x 18,7	G-LMA5-137227
13,7 x 22,7	G-LMA5-137227
13,7 x 27,7	G-LMA5-137277
13,7 x 31,7	G-LMA5-137317
15,7 x 20,7	G-LMA5-157207
15,7 x 24,7	G-LMA5-157247
15,7 x 27,7	G-LMA5-157277
17,7 x 22,7	G-LMA5-177227
17,2 x 31,2	G-LMA5-172312
17,7 x 31,7	G-LMA5-177317
19,7 x 31,7	G-LMA5-197317
21,2 x 27,2	G-LMA5-212272
21,7 x 27,7	G-LMA5-217277

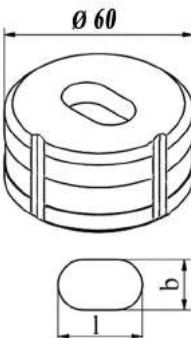
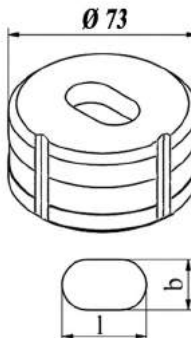
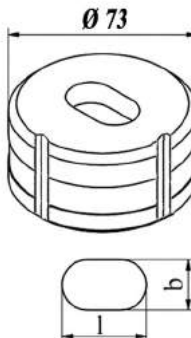
Langloch-Matrize oblong die		Nr. 8	Langloch-Matrize oblong die		Nr. 10	Langloch-Matrize oblong die		Nr. 10
								
b x l	Best-Nr.	b x l	Best-Nr.	b x l	Best-Nr.	b x l	Best-Nr.	
9,7 x 40,7	G-LMA8-097407	5,2 x 10,2	G-LMA10-052102	10,2 x 14,2	G-LMA10-102142			
10,7 x 40,7	G-LMA8-107407	5,7 x 10,7	G-LMA10-057107	10,7 x 14,7	G-LMA10-107147			
11,7 x 40,7	G-LMA8-117407	5,2 x 14,2	G-LMA10-052142	10,2 x 20,2	G-LMA10-102202			
13,7 x 40,7	G-LMA8-137407	5,7 x 14,7	G-LMA10-057147	10,7 x 20,7	G-LMA10-107207			
14,7 x 40,7	G-LMA8-147407	5,7 x 10,2	G-LMA10-057102	10,2 x 26,2	G-LMA10-102262			
16,7 x 40,7	G-LMA8-167407	6,2 x 10,7	G-LMA10-062107	10,7 x 26,7	G-LMA10-107267			
17,7 x 40,7	G-LMA8-177407	5,7 x 14,2	G-LMA10-057142	10,2 x 30,2	G-LMA10-102302			
18,7 x 36,7	G-LMA8-187367	6,2 x 14,7	G-LMA10-062147	10,7 x 30,7	G-LMA10-107307			
18,7 x 40,7	G-LMA8-187407	5,7 x 19,2	G-LMA10-057192	11,2 x 22,2	G-LMA10-112222			
19,7 x 40,7	G-LMA8-197407	6,2 x 19,7	G-LMA10-062197	11,7 x 22,7	G-LMA10-117227			
20,7 x 40,7	G-LMA8-207407	5,7 x 25,2	G-LMA10-057252	11,7 x 26,7	G-LMA10-117267			
22,7 x 40,7	G-LMA8-227407	6,2 x 25,7	G-LMA10-062257	11,2 x 30,2	G-LMA10-112302			
24,7 x 40,7	G-LMA8-247407	6,7 x 12,2	G-LMA10-067122	11,7 x 30,7	G-LMA10-117307			
26,7 x 40,7	G-LMA8-267407	7,2 x 12,7	G-LMA10-072127	11,2 x 40,2	G-LMA10-112402			
		6,7 x 18,2	G-LMA10-067182	11,7 x 40,7	G-LMA10-117407			
		7,2 x 18,7	G-LMA10-072187	12,2 x 24,2	G-LMA10-122242			
		6,7 x 26,2	G-LMA10-067262	12,7 x 24,7	G-LMA10-127247			
		7,2 x 26,7	G-LMA10-072267	12,2 x 30,2	G-LMA10-122302			
		6,7 x 30,2	G-LMA10-067302	12,7 x 30,7	G-LMA10-127307			
		7,2 x 30,7	G-LMA10-072307	12,2 x 35,2	G-LMA10-122352			
		7,7 x 14,2	G-LMA10-077142	12,7 x 35,7	G-LMA10-127357			
		8,2 x 14,7	G-LMA10-082217	12,2 x 40,2	G-LMA10-122402			
		7,7 x 21,2	G-LMA10-077212	12,7 x 40,7	G-LMA10-127407			
		8,2 x 21,7	G-LMA10-082217	13,2 x 26,2	G-LMA10-132262			
		7,7 x 26,2	G-LMA10-077302	13,7 x 26,7	G-LMA10-137267			
		8,2 x 26,7	G-LMA10-082267	13,2 x 30,2	G-LMA10-132302			
		7,7 x 30,2	G-LMA10-077302	13,7 x 30,7	G-LMA10-137307			
		8,2 x 30,7	G-LMA10-082307	13,2 x 35,2	G-LMA10-132352			
		9,2 x 14,2	G-LMA10-092142	13,7 x 35,7	G-LMA10-137357			
		9,7 x 14,7	G-LMA10-097147	13,2 x 40,2	G-LMA10-132402			
		9,2 x 18,2	G-LMA10-092182	13,7 x 40,7	G-LMA10-137407			
		9,7 x 18,7	G-LMA10-097187	14,2 x 26,2	G-LMA10-142262			
		9,2 x 26,2	G-LMA10-092262	14,7 x 26,7	G-LMA10-147267			
		9,7 x 26,7	G-LMA10-097267	14,2 x 28,2	G-LMA10-142282			
		9,2 x 30,2	G-LMA10-092302	14,7 x 28,7	G-LMA10-147287			
		9,7 x 30,7	G-LMA10-097307	14,2 x 35,2	G-LMA10-147352			

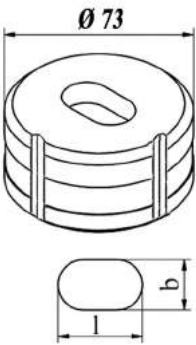
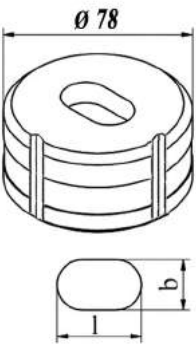
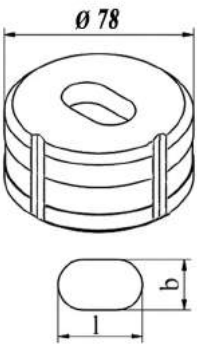
Langloch-Matrize		Nr. 10	Langloch-Matrize		Nr. 11	Langloch-Matrize		Nr. 11
oblong die			oblong die			oblong die		
								
b x l	Best-Nr.		b x l	Best-Nr.		b x l	Best-Nr.	
14,7 x 35,7	G-LMA10-147357		10,2 x 30,2	G-LMA11-102302		22,2 x 40,2	G-LMA11-222402	
14,2 x 40,2	G-LMA10-147402		10,7 x 30,7	G-LMA11-107307		22,7 x 40,7	G-LMA11-227407	
14,7 x 40,7	G-LMA10-147407		11,2 x 30,2	G-LMA11-112302		22,2 x 45,2	G-LMA11-222452	
16,2 x 26,2	G-LMA10-162262		11,7 x 30,7	G-LMA11-117307		22,7 x 45,7	G-LMA11-227457	
16,7 x 26,7	G-LMA10-167267		12,2 x 30,2	G-LMA11-122302		22,2 x 50,2	G-LMA11-222502	
16,2 x 31,2	G-LMA10-162312		12,7 x 30,7	G-LMA11-127307		22,7 x 50,7	G-LMA11-227507	
16,7 x 31,7	G-LMA10-167317		12,2 x 35,2	G-LMA11-122352				
16,2 x 40,2	G-LMA10-167402		12,7 x 35,7	G-LMA11-127357				
16,7 x 40,7	G-LMA10-167407		12,2 x 40,2	G-LMA11-122402				
18,2 x 26,2	G-LMA10-182262		12,7 x 40,7	G-LMA11-127407				
18,7 x 26,7	G-LMA10-187267		13,2 x 30,2	G-LMA11-132302				
18,2 x 31,2	G-LMA10-182312		13,7 x 30,7	G-LMA11-137307				
18,7 x 31,7	G-LMA10-187317		13,2 x 35,2	G-LMA11-132352				
18,2 x 36,2	G-LMA10-187362		13,7 x 35,7	G-LMA11-137357				
18,7 x 36,7	G-LMA10-187367		13,2 x 40,2	G-LMA11-132402				
18,2 x 40,2	G-LMA10-187402		13,7 x 40,7	G-LMA11-137407				
18,7 x 40,7	G-LMA10-187407		14,2 x 28,2	G-LMA11-142282				
20,2 x 31,2	G-LMA10-202312		14,7 x 28,7	G-LMA11-147287				
20,7 x 31,7	G-LMA10-207317		14,2 x 35,2	G-LMA11-142352				
20,2 x 40,2	G-LMA10-202402		14,7 x 35,7	G-LMA11-147357				
20,7 x 40,7	G-LMA10-207407		14,2 x 40,2	G-LMA11-142402				
22,2 x 31,2	G-LMA10-222312		14,7 x 40,7	G-LMA11-147407				
22,7 x 31,7	G-LMA10-227317		16,2 x 31,2	G-LMA11-162312				
22,2 x 40,2	G-LMA10-222402		16,7 x 31,7	G-LMA11-167317				
22,7 x 40,7	G-LMA10-227407		16,2 x 40,2	G-LMA11-162402				
			16,7 x 40,7	G-LMA11-167407				
			18,2 x 31,2	G-LMA11-182312				
			18,7 x 31,7	G-LMA11-187317				
			18,2 x 40,2	G-LMA11-182402				
			18,7 x 40,7	G-LMA11-187407				
			20,2 x 31,2	G-LMA11-202312				
			20,7 x 31,7	G-LMA11-207317				
			20,2 x 40,2	G-LMA11-202402				
			20,7 x 40,7	G-LMA11-207407				
			22,2 x 31,2	G-LMA11-222312				
			22,7 x 31,7	G-LMA11-227317				

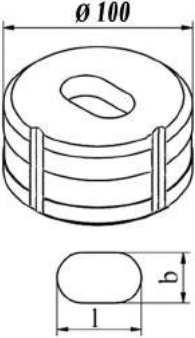
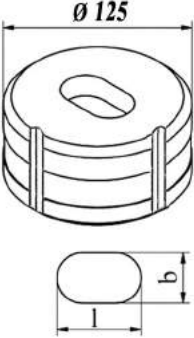
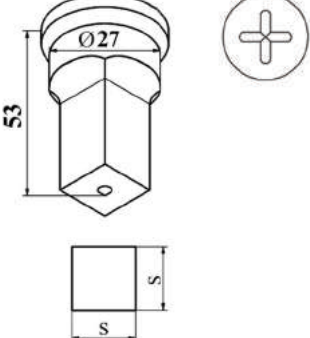
Langloch-Matrize	Nr. 12	Langloch-Matrize	Nr. 13	Vierkant-Stempel	Nr. 5-27
oblong die		oblong die		square punch	
					
b x l	Best-Nr.	b x l	Best-Nr.	s=	Best.-Nr.
16,5 x 55,5 18,5 x 55,5 20,5 x 55,5 22,5 x 55,5	G-LMA12-165555 G-LMA12-185555 G-LMA12-205555 G-LMA12-225555	Preis auf Anfrage / price on application		4.0 5.0 6.0 7.0 8.0 9.0 10.0 11.0 12.0 13.0 14.0 15.0 16.0 17.0 18.0 19.0 *20.0	G-VKS527-0040 G-VKS527-0050 G-VKS527-0060 G-VKS527-0070 G-VKS527-0080 G-VKS527-0090 G-VKS527-0100 G-VKS527-0110 G-VKS527-0120 G-VKS527-0130 G-VKS527-0140 G-VKS527-0150 G-VKS527-0160 G-VKS527-0170 G-VKS527-0180 G-VKS527-0190 G-VKS527-0200
					* Übergröße

**Vierkant-
Stempel**

square punch

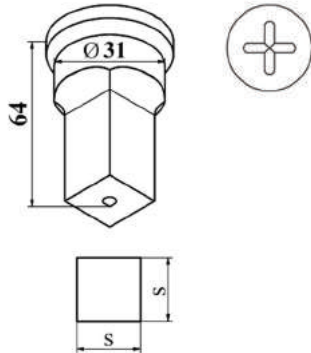
Nr. 8-31

s=	Best.-Nr.
4.0	G-VKS831-0040
5.0	G-VKS831-0050
6.0	G-VKS831-0060
7.0	G-VKS831-0070
8.0	G-VKS831-0080
9.0	G-VKS831-0090
10.0	G-VKS831-0100
11.0	G-VKS831-0110
12.0	G-VKS831-0120
13.0	G-VKS831-0130
14.0	G-VKS831-0140
15.0	G-VKS831-0150
16.0	G-VKS831-0160
17.0	G-VKS831-0170
18.0	G-VKS831-0180
19.0	G-VKS831-0190
20.0	G-VKS831-0200
21.0	G-VKS831-0210
22.0	G-VKS831-0220

**Vierkant-
Stempel**

square punch

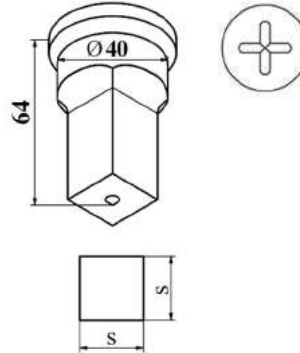
Nr. 8-40

s=	Best.-Nr.
22.0	G-VKS840-0220
23.0	G-VKS840-0230
24.0	G-VKS840-0240
25.0	G-VKS840-0250
26.0	G-VKS840-0260
27.0	G-VKS840-0270
28.0	G-VKS840-0280

**Vierkant-
Stempel**

square punch

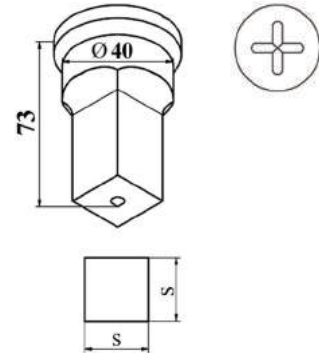

Nr. 10-40

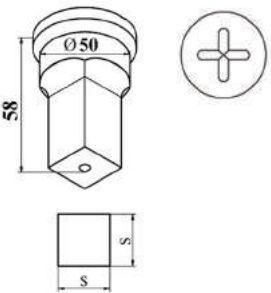
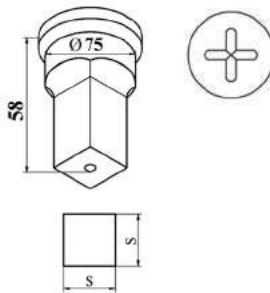
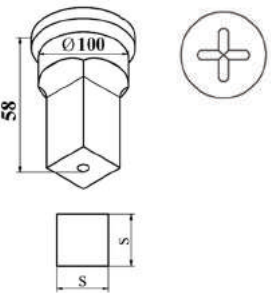
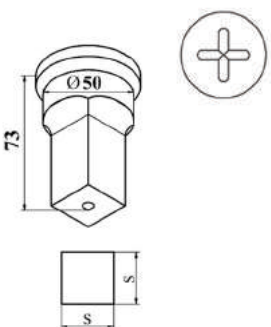
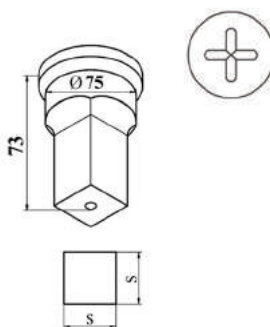
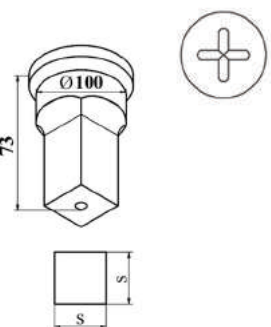
s=	Best.-Nr.
16.0	G-VKS1040-0160
17.0	G-VKS1040-0170
18.0	G-VKS1040-0180
19.0	G-VKS1040-0190
20.0	G-VKS1040-0200
21.0	G-VKS1040-0210
22.0	G-VKS1040-0220
23.0	G-VKS1040-0230
24.0	G-VKS1040-0240
25.0	G-VKS1040-0250
26.0	G-VKS1040-0260
27.0	G-VKS1040-0270
28.0	G-VKS1040-0280

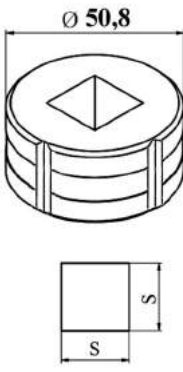
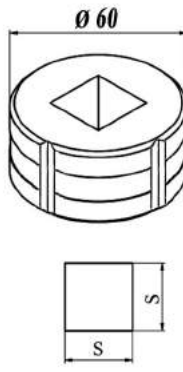
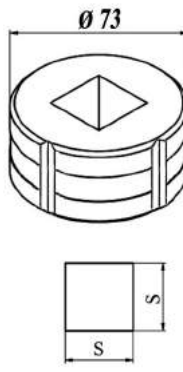
<p>Vierkant-Stempel Nr. 11 square punch</p>  <p>s= Best.-Nr.</p> <p>20.0 G-VKS11-0200 21.0 G-VKS11-0210 22.0 G-VKS11-0220 23.0 G-VKS11-0230 24.0 G-VKS11-0240 25.0 G-VKS11-0250 26.0 G-VKS11-0260 27.0 G-VKS11-0270 28.0 G-VKS11-0280 29.0 G-VKS11-0290 30.0 G-VKS11-0300 31.0 G-VKS11-0310 32.0 G-VKS11-0320 33.0 G-VKS11-0330 34.0 G-VKS11-0340 35.0 G-VKS11-0350</p>	<p>Vierkant-Stempel Nr. 12 square punch</p>  <p>s= Best.-Nr.</p> <p>40.0 G-VKS12-0400 45.0 G-VKS12-0450 50.0 G-VKS12-0500</p>	<p>Vierkant-Stempel Nr. 13 square punch</p>  <p>s= Best.-Nr.</p> <p>55.0 G-VKS13-0550 60.0 G-VKS13-0600 65.0 G-VKS13-0650 70.0 G-VKS13-0700</p>
<p>Vierkant-Stempel Nr. 11 A square punch</p>  <p>s= Best.-Nr.</p> <p>31.0 G-VKS11A-0310 33.0 G-VKS11A-0330 35.0 G-VKS11A-0350</p>	<p>Vierkant-Stempel Nr. 12 A square punch</p>  <p>s= Best.-Nr.</p> <p>40.0 G-VKS12A-0400 45.0 G-VKS12A-0450 50.0 G-VKS12A-0500</p>	<p>Vierkant-Stempel Nr. 13 A square punch</p>  <p>s= Best.-Nr.</p> <p>55.0 G-VKS13A-0550 60.0 G-VKS13A-0600 65.0 G-VKS13A-0650 70.0 G-VKS13A-0700</p>

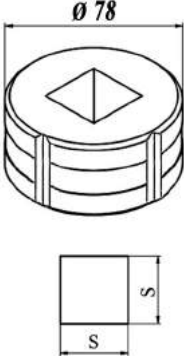
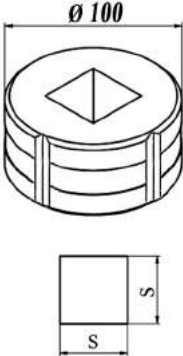
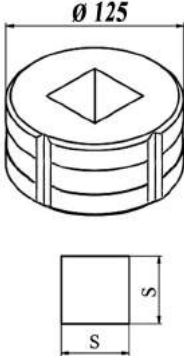
Vierkant-Matrize square die		Nr. 5	Vierkant-Matrize square die		Nr. 8	Vierkant-Matrize square die		Nr. 10	
									
s=	Best.-Nr.	s=	Best.-Nr.	s=	Best.-Nr.	s=	Best.-Nr.		
4.2	G-VKM5-0042	4.2	G-VKM8-0042	15.2	G-VKM10-0152	4.2	G-VKM5-0042	15.2	G-VKM10-0152
5.2	G-VKM5-0052	4.7	G-VKM8-0047	15.7	G-VKM10-0157	5.2	G-VKM5-0052	15.7	G-VKM10-0157
6.2	G-VKM5-0062	5.2	G-VKM8-0052	16.2	G-VKM10-0162	6.2	G-VKM5-0062	16.2	G-VKM10-0162
6.7	G-VKM5-0067	5.7	G-VKM8-0057	16.7	G-VKM10-0167	6.7	G-VKM5-0067	16.7	G-VKM10-0167
7.2	G-VKM5-0072	6.2	G-VKM8-0062	17.2	G-VKM10-0172	7.2	G-VKM5-0072	17.2	G-VKM10-0172
7.7	G-VKM5-0077	6.7	G-VKM8-0067	17.7	G-VKM10-0177	7.7	G-VKM5-0077	17.7	G-VKM10-0177
8.2	G-VKM5-0082	7.2	G-VKM8-0072	18.2	G-VKM10-0182	8.2	G-VKM5-0082	18.2	G-VKM10-0182
8.7	G-VKM5-0087	7.7	G-VKM8-0077	18.7	G-VKM10-0187	8.7	G-VKM5-0087	18.7	G-VKM10-0187
9.2	G-VKM5-0092	8.2	G-VKM8-0082	19.2	G-VKM10-0192	9.2	G-VKM5-0092	19.2	G-VKM10-0192
9.7	G-VKM5-0097	8.7	G-VKM8-0087	19.7	G-VKM10-0197	9.7	G-VKM5-0097	19.7	G-VKM10-0197
10.2	G-VKM5-0102	9.2	G-VKM8-0092	20.2	G-VKM10-0202	10.2	G-VKM5-0102	20.2	G-VKM10-0202
10.7	G-VKM5-0107	9.7	G-VKM8-0097	20.7	G-VKM10-0207	10.7	G-VKM5-0107	20.7	G-VKM10-0207
11.2	G-VKM5-0112	10.2	G-VKM8-0102	21.2	G-VKM10-0212	11.2	G-VKM5-0112	21.2	G-VKM10-0212
11.7	G-VKM5-0117	10.7	G-VKM8-0107	21.7	G-VKM10-0217	11.7	G-VKM5-0117	21.7	G-VKM10-0217
12.2	G-VKM5-0122	11.2	G-VKM8-0112	22.2	G-VKM10-0222	12.2	G-VKM5-0122	22.2	G-VKM10-0222
12.7	G-VKM5-0127	11.7	G-VKM8-0117	22.7	G-VKM10-0227	12.7	G-VKM5-0127	22.7	G-VKM10-0227
13.2	G-VKM5-0132	12.2	G-VKM8-0122	23.2	G-VKM10-0232	13.2	G-VKM5-0132	23.2	G-VKM10-0232
13.7	G-VKM5-0137	12.7	G-VKM8-0127	23.7	G-VKM10-0237	13.7	G-VKM5-0137	23.7	G-VKM10-0237
14.2	G-VKM5-0142	13.2	G-VKM8-0132	24.2	G-VKM10-0242	14.2	G-VKM5-0142	24.2	G-VKM10-0242
14.7	G-VKM5-0147	13.7	G-VKM8-0137	24.7	G-VKM10-0247	14.7	G-VKM5-0147	24.7	G-VKM10-0247
15.2	G-VKM5-0152	14.2	G-VKM8-0142	25.2	G-VKM10-0252	15.2	G-VKM5-0152	25.2	G-VKM10-0252
15.7	G-VKM5-0157	14.7	G-VKM8-0147	25.7	G-VKM10-0257	15.7	G-VKM5-0157	25.7	G-VKM10-0257
16.2	G-VKM5-0162	15.2	G-VKM8-0152	26.2	G-VKM10-0262	16.2	G-VKM5-0162	26.2	G-VKM10-0262
16.7	G-VKM5-0167	15.7	G-VKM8-0157	26.7	G-VKM10-0267	16.7	G-VKM5-0167	26.7	G-VKM10-0267
17.2	G-VKM5-0172	16.2	G-VKM8-0162	27.2	G-VKM10-0272	17.2	G-VKM5-0172	27.2	G-VKM10-0272
17.7	G-VKM5-0177			27.7	G-VKM10-0277	17.7	G-VKM5-0177	27.7	G-VKM10-0277
18.2	G-VKM5-0182			28.2	G-VKM10-0282	18.2	G-VKM5-0182	28.2	G-VKM10-0282
18.7	G-VKM5-0187			28.7	G-VKM10-0287	18.7	G-VKM5-0187	28.7	G-VKM10-0287
19.2	G-VKM5-0192					19.2	G-VKM5-0192		
19.7	G-VKM5-0197					19.7	G-VKM5-0197		
20.2	G-VKM5-0202					20.2	G-VKM5-0202		
20.7	G-VKM5-0207					20.7	G-VKM5-0207		
21.2	G-VKM5-0212					21.2	G-VKM5-0212		
21.7	G-VKM5-0217					21.7	G-VKM5-0217		
22.2	G-VKM5-0222					22.2	G-VKM5-0222		
22.7	G-VKM5-0227					22.7	G-VKM5-0227		

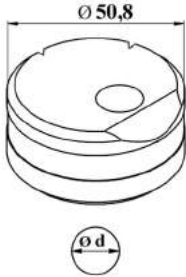
Vierkant-Matrize	Nr. 11	Vierkant-Matrize	Nr. 12	Vierkant-Matrize	Nr. 13
square die		square die		square die	
					
s=	Best.-Nr.	s=	Best.-Nr.	s=	Best.-Nr.
20.2	G-VKM11-0202	40.3	G-VKM12-0403	55.3	G-VKM13-0553
20.7	G-VKM11-0207	45.3	G-VKM12-0453	60.3	G-VKM13-0603
21.2	G-VKM11-0212	50.3	G-VKM12-0503	65.3	G-VKM13-0653
21.7	G-VKM11-0217			70.3	G-VKM13-0703
22.2	G-VKM11-0222				
22.7	G-VKM11-0227				
23.2	G-VKM11-0232				
23.7	G-VKM11-0237				
24.2	G-VKM11-0242				
24.7	G-VKM11-0247				
25.2	G-VKM11-0252				
25.7	G-VKM11-0257				
26.2	G-VKM11-0262				
26.7	G-VKM11-0267				
27.2	G-VKM11-0272				
27.7	G-VKM11-0277				
28.2	G-VKM11-0282				
28.7	G-VKM11-0287				
29.2	G-VKM11-0292				
29.7	G-VKM11-0297				
30.2	G-VKM11-0302				
30.7	G-VKM11-0307				
31.2	G-VKM11-0312				
31.7	G-VKM11-0317				
32.2	G-VKM11-0322				
32.7	G-VKM11-0327				
33.2	G-VKM11-0332				
33.7	G-VKM11-0337				
34.2	G-VKM11-0342				
34.7	G-VKM11-0347				
35.2	G-VKM11-0352				
35.7	G-VKM11-0357				

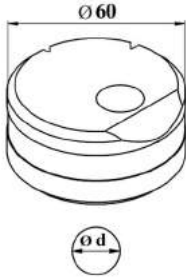
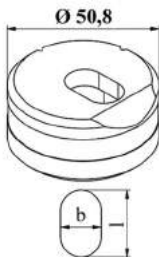
Winkelstahl- Matrize offset round die		Langloch- Winkelstahl- Matrize quer oblong offset die transverse		Winkelstahl- Matrize offset round die	
Nr. 5 E		Nr. 5 E		Nr. 8 E	
					
d=	Best.-Nr.	b x l	Best.-Nr.	d=	Best.-Nr.
6.2	G-WSM5E-0062	6,2 x 14,7	G-LWQ5E-062147	31.2	G-WSM8E-0312
6.7	G-WSM5E-0067	6,2 x 25,7	G-LWQ5E-062257	31.7	G-WSM8E-0317
7.2	G-WSM5E-0072	7,2 x 26,7	G-LWQ5E-072267	32.2	G-WSM8E-0322
7.7	G-WSM5E-0077	8,2 x 26,7	G-LWQ5E-082267	32.7	G-WSM8E-0327
8.2	G-WSM5E-0082	9,7 x 14,7	G-LWQ5E-097147	33.2	G-WSM8E-0332
8.7	G-WSM5E-0087	9,7 x 26,7	G-LWQ5E-097267	33.7	G-WSM8E-0337
9.2	G-WSM5E-0092	10,7 x 20,7	G-LWQ5E-107207	34.2	G-WSM8E-0342
9.7	G-WSM5E-0097	11,7 x 22,7	G-LWQ5E-117227	34.7	G-WSM8E-0347
10.2	G-WSM5E-0102	11,7 x 26,7	G-LWQ5E-117267	35.2	G-WSM8E-0352
10.7	G-WSM5E-0107	13,7 x 26,7	G-LWQ5E-137267	35.7	G-WSM8E-0357
11.2	G-WSM5E-0112	14,7 x 26,7	G-LWQ5E-147267	36.2	G-WSM8E-0362
11.7	G-WSM5E-0117	16,7 x 26,7	G-LWQ5E-167267	36.7	G-WSM8E-0367
12.2	G-WSM5E-0122			37.2	G-WSM8E-0372
12.7	G-WSM5E-0127			37.7	G-WSM8E-0377
13.2	G-WSM5E-0132			38.2	G-WSM8E-0382
13.7	G-WSM5E-0137			38.7	G-WSM8E-0387
14.2	G-WSM5E-0142			39.2	G-WSM8E-0392
14.7	G-WSM5E-0147			39.7	G-WSM8E-0397
15.2	G-WSM5E-0152			40.2	G-WSM8E-0402
15.7	G-WSM5E-0157			40.7	G-WSM8E-0407
16.2	G-WSM5E-0162				
16.7	G-WSM5E-0167				
17.2	G-WSM5E-0172				
17.7	G-WSM5E-0177				
18.2	G-WSM5E-0182				
18.7	G-WSM5E-0187				
19.2	G-WSM5E-0192				
19.7	G-WSM5E-0197				
20.2	G-WSM5E-0202				
20.7	G-WSM5E-0207				
21.2	G-WSM5E-0212				
21.7	G-WSM5E-0217				
22.2	G-WSM5E-0222				
22.7	G-WSM5E-0227				
23.2	G-WSM5E-0232				
23.7	G-WSM5E-0237				
24.2	G-WSM5E-0242				
24.7	G-WSM5E-0247				
		Langloch- Winkelstahl- Matrize längs oblong offset die longitudinal			
					
		b x l	Best.-Nr.		
		6,2 x 14,7	G-LWL5E-062147		
		6,2 x 25,7	G-LWL5E-062257		
		7,2 x 26,7	G-LWL5E-072267		
		8,2 x 26,7	G-LWL5E-082267		
		9,7 x 14,7	G-LWL5E-097147		
		9,7 x 26,7	G-LWL5E-097267		
		10,7 x 20,7	G-LWL5E-107207		
		11,7 x 22,7	G-LWL5E-117227		
		11,7 x 26,7	G-LWL5E-117267		
		13,7 x 26,7	G-LWL5E-137267		
		14,7 x 26,7	G-LWL5E-147267		
		16,7 x 26,7	G-LWL5E-167267		

**Schlüsselloch-Stempel
zum Stanzen von Löchern
für Profilzylinder**

key hole punch for punching
holes for sectional cylinders

**Schlüsselloch-Matrize
zum Stanzen von Löchern
für Profilzylinder**

key hole die for punching
holes for sectional cylinders

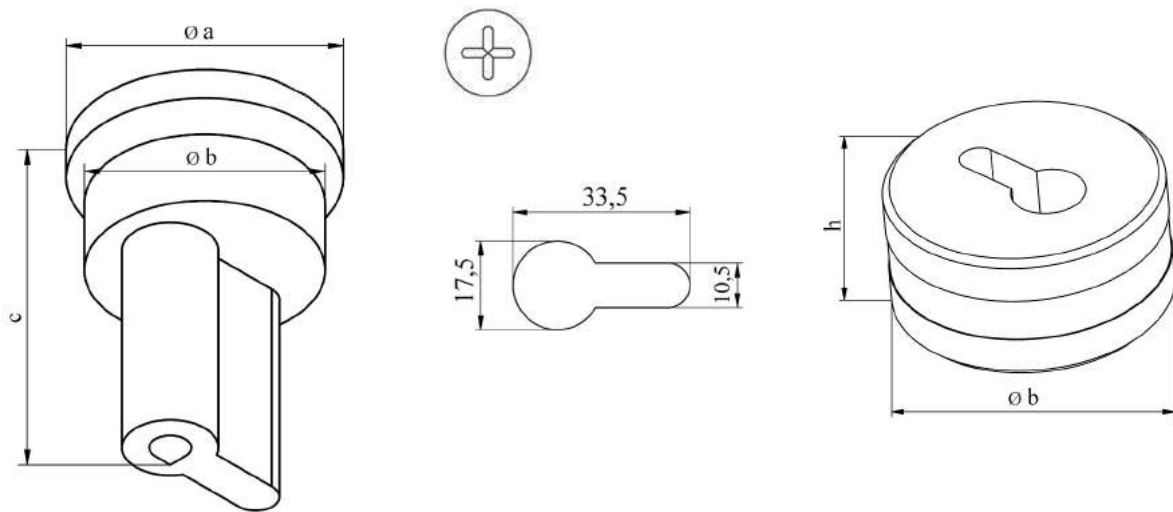

Stempel Nr.	\varnothing a	\varnothing b	c	Bestell-Nr.	Matrize Nr.	h	\varnothing b	Bestell-Nr.
5-27				auf Anfrage / on application	5			auf Anfrage / on application
8-31				auf Anfrage / on application	8	32	60	G-SLM8-337177107
8-40	43.5	40	64	G-SLS840-335175105				

Abmessung: 33,5 x 17,5 x 10,5 mm

Abmessung: 33,7 x 17,7 x 10,7 mm

Bei Bestellung bitte angeben:

When ordering please state:

Materialstärke + Festigkeit

Material thickness + tensile strength

**Eckenabrund-Stempel
zum Abrunden von Ecken
(90°) für Flachmaterial**

corner radiusing punch for rounding off
corners (90°) of flats

**Eckenabrund-Matrize
zum Abrunden von Ecken
(90°) für Flachmaterial**

corner radiusing die for rounding off
corners (90°) of flats

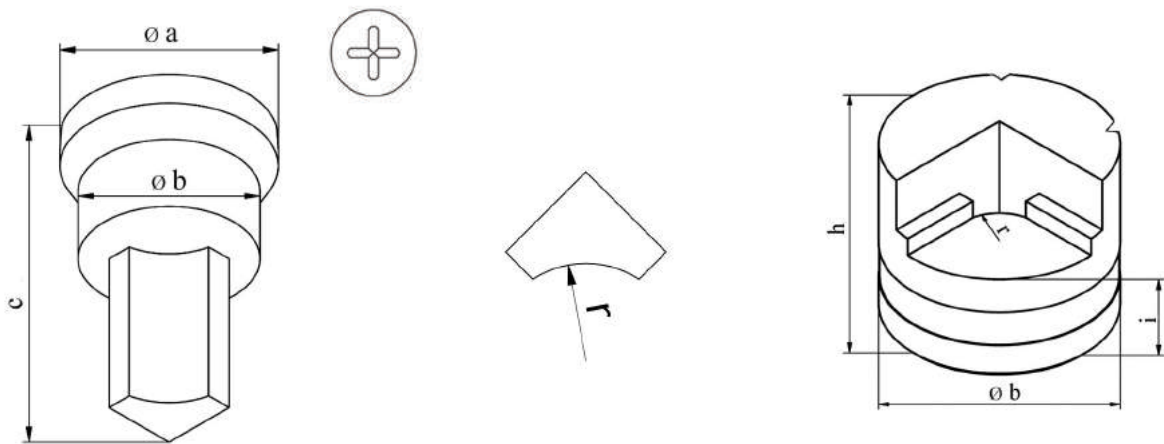

Stempel Nr.	Ø a	Ø b	c	r	Bestell-Nr.	Matrizen Nr.	i	Ø b	Bestell-Nr.
5-27	30.5	27	53	(1)	G-EAS0527-0000xx	5	25.5	50.8	G-EAM5-0000xx
8-31	35	31	64	(2)	G-EAS0831-0000xx				
8-40	43.5	40	64	(3)	G-EAS0840-0000xx	8	32	60	G-EAM8-0000xx
10-40	43.5	40	73	26	G-EAS1040-000026				
11	54	50	58		auf Anfrage/on application	10	32	73	auf Anfrage/on application
12	79	75	58		auf Anfrage/on application	11	28.5	78	auf Anfrage/on application
13	104	100	58		auf Anfrage/on application	12	28.5	100	auf Anfrage/on application
						13	28.5	125	auf Anfrage/on application

Bei Bestellung bitte angeben:

Materialstärke + Festigkeit

(1) Radius: 5 mm, 10 mm

(2) Radius: 5 mm, 10 mm, 15 mm, 18 mm

(3) Radius: 20 mm, 26 mm

When ordering please state:

Material thickness + tensile strength

**Trenn-Abrund-Stempel
von Flachstahl**

shearing and one-sided
radiusing punch

**Trenn-Abrund-Matrize
von Flachstahl**

shearing and one-sided
radiusing die

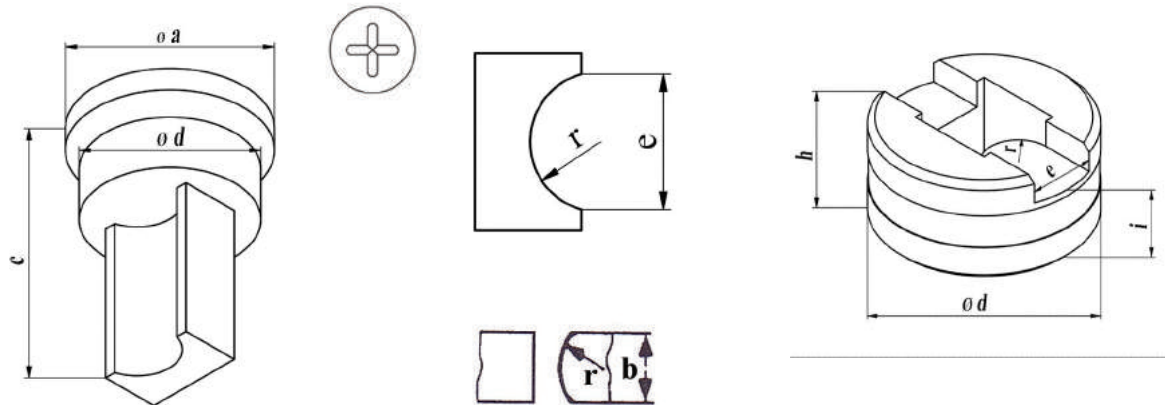

Stempel Nr	Ø a	Ø d	c	e	r	Bestell-Nr.	Matrize Nr.	h	Ø d	Bestell-Nr.
5-27	30.5	27	53	20 x 6	15	G-TAS527-000015	5	25.5	50.8	G-TAM5-000015
				20 x 10	20	G-TAS527-000020				G-TAM5-000020
8-31	35	31	64	20 x 8	15	G-TAS831-000015	8	32	60	G-TAM8-000015
				25 x 8	25	G-TAS831-000025				G-TAM8-000025
8-40	43.5	40	64	30 x 8	20	G-TAS840-000020	10	32	73	G-TAM8-000020
				30 x 10	30	G-TAS840-000030				G-TAM8-000025
10-40	43.5	40	73	30 x 8	20	G-TAS1040-000020	11	28.5	78	G-TAM10-000020
				30 x 10	30	G-TAS1040-000030				G-TAM10-000030
11	54	50	58	40 x 10	30	G-TAS11-000030	12	28.5	100	G-TAM11-000030
				40 x 12	40	G-TAS11-000040				G-TAM11-000040
12	79	75	58	50 x 10	30	G-TAS12-000030	13	28.5	125	G-TAM12-000030
				60 x 14	45	G-TAS12-000045				G-TAM2-000045
13	104	100	58	70 x 12	40	G-TAS13-000040				G-TAM13-000040
				80 x 14	60	G-TAS13-000060				G-TAM13-000060

e = Material x Stärke
b = Materialbreite

Bei Bestellung bitte angeben:

Materialbreite
Materialstärke
Materialfestigkeit

When ordering please state:

material width
material thickness
material tensile strength

**Trenn-Doppel-Abrund-Stempel
von Flachstahl**

shearing and double-sided
radiusing punch

**Trenn-Doppel-Abrund-Matrize
von Flachstahl**

shearing and double-sided
radiusing die

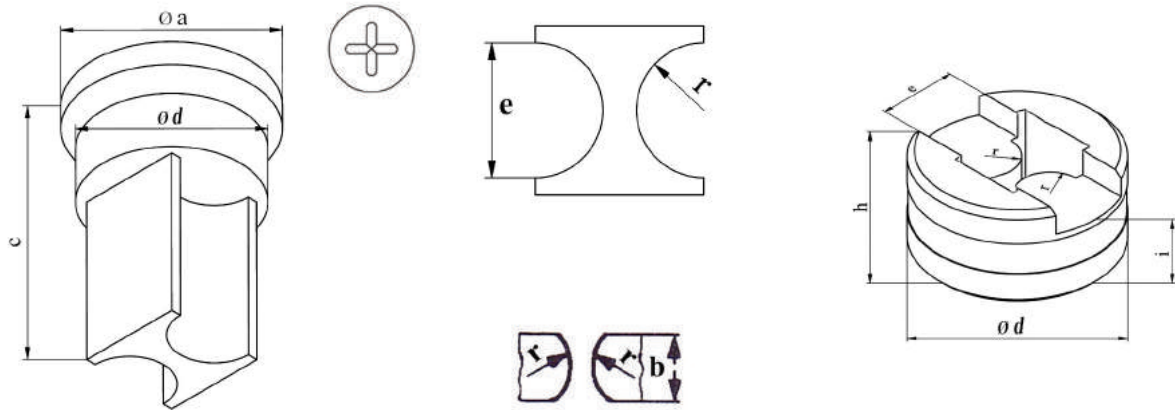

Stempel Nr	Ø a	Ø d	c	e	r	Bestell-Nr.	Matrize Nr.	h	Ø d	Bestell-Nr.
5-27	30.5	27	53	20 x 6	15	G-TDS527-0000015	5	25.5	50.8	G-TDM5-000015
				20 x 10	20	G-TDS527-0000020				G-TDM5-000020
8-31	35	31	64	20 x 8	15	G-TDS831-0000015	8	32	60	G-TDM5-000025
				25 x 8	25	G-TDS831-0000025				G-TDM8-000015
8-40	43.5	40	64	30 x 8	20	G-TDS840-0000020	10	32	73	G-TDM8-000020
				30 x 10	30	G-TDS840-0000030				G-TDM8-000025
10-40	43.5	40	73	30 x 8	20	G-TDS1040-0000020	11	28.5	78	G-TDM10-000020
				30 x 10	30	G-TDS1040-0000030				G-TDM10-000030
11	54	50	58	40 x 10	30	G-TDS11-0000030	12	28.5	100	G-TDM11-000030
				40 x 12	40	G-TDS11-0000040				G-TDM11-000040
12	79	75	58	50 x 10	30	G-TDS12-0000030	13	28.5	125	G-TDM12-000030
				60 x 14	45	G-TDS12-0000045				G-TDM2-000045
13	104	100	58	70 x 12	40	G-TDS13-0000040				G-TDM13-000040
				80 x 14	60	G-TDS13-0000060				G-TDM13-000060

e = Material x Stärke
b = Materialbreite

Bei Bestellung bitte angeben:

Materialstärke + Festigkeit

When ordering please state:

material thickness + tensile strength



Die in diesem Katalog genannten Preise sind Grundpreise in EURO, bei Wiederverkauf durch den Handel jedoch unverbindliche Preisempfehlungen. Die Mehrwertsteuer ist in den Preisen nicht enthalten und wird separat ausgewiesen.

Für Zwischenabmessungen und abweichendes Schneidspiel wird ein Aufpreis pro Stempel und pro Matrize berechnet.

Preisstellung: ab Werk; ausschl. Verpackung

Um Ihren Auftrag schnell, genau und mit der nötigen Sorgfalt zu bearbeiten, bitten wir Sie, folgende Punkte zu prüfen bzw. zu beachten:

- passen die gewünschten Stempel und Matrizen in die Werkzeugaufnahme der vorhandenen Maschinen. Form und Abmessung der Stempel und Matrizen sind auf den Katalogseiten ersichtlich, eventuell bitte an vorhandenen Werkzeugen prüfen.
- ist das Eckenmaß der zu stanzenden Form nicht größer als der Schaftdurchmesser des Stempels
- sind Reduzierungen von einer größeren Vorrichtung auf die gewünschten kleineren Stempel und Matrizen vorhanden.
- Bei Stempeln und Matrizen, die von der Katalognorm und -form abweichen, geben Sie bitte die zu bearbeitende Materialstärke und -qualität an.

Damit sich die Lebensdauer von Stempeln und Matrizen verlängert und die Stanzqualität verbessert wird, sollten folgende Punkte beachtet werden:

- richtiges Schneidspiel zwischen Stempel und Matrize, d. h. 10 % der Materialstärke (bei Sondermaterial eventuell Rücksprache)
- beim Einbau der Werkzeuge auf gleichmäßiges Spiel zwischen Stempel und Matrize achten.
- beim Stanzen mit Stempelsprühgeräten arbeiten oder den Stempel manuell mit Stanzöl bestreichen.
- bei Formstempeln muss die mitgelieferte Passfeder eingebaut werden.
- Stempel und Matrize müssen fest und sicher in der Vorrichtung eingebaut sein. (Fingerschutzklappe anbringen)
- der Abstreifer muss parallel zur Matrizenoberfläche sein, bei höheneinstellbaren Abstreifern, nahe an Materialoberfläche absenken.
- der Stempeldurchmesser darf nicht kleiner sein, wie die zu stanzende Materialstärke.
- zum Schutz von Maschine und Werkzeug sollte die benötigte Stanzkraft nach folgender Formel überprüft werden:

$\text{Lochumfang} \times \text{Materialstärke} \times \text{Materialfestigkeit}$

Wir stehen Ihnen bei Fragen jederzeit gerne zur Verfügung.

Katalog-Nr. 2, Ausgabe 2015

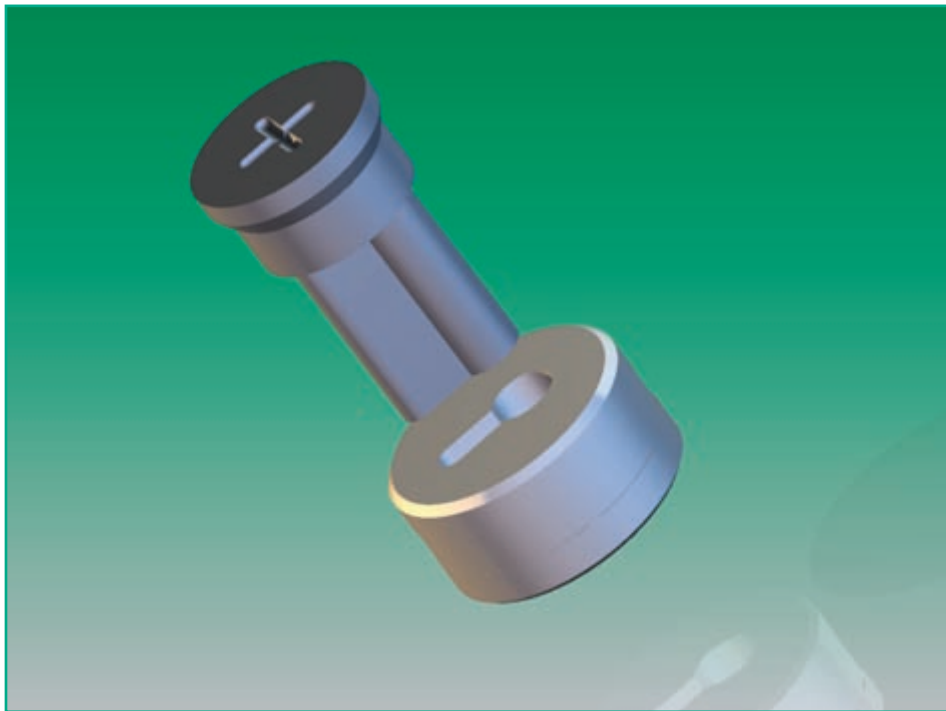
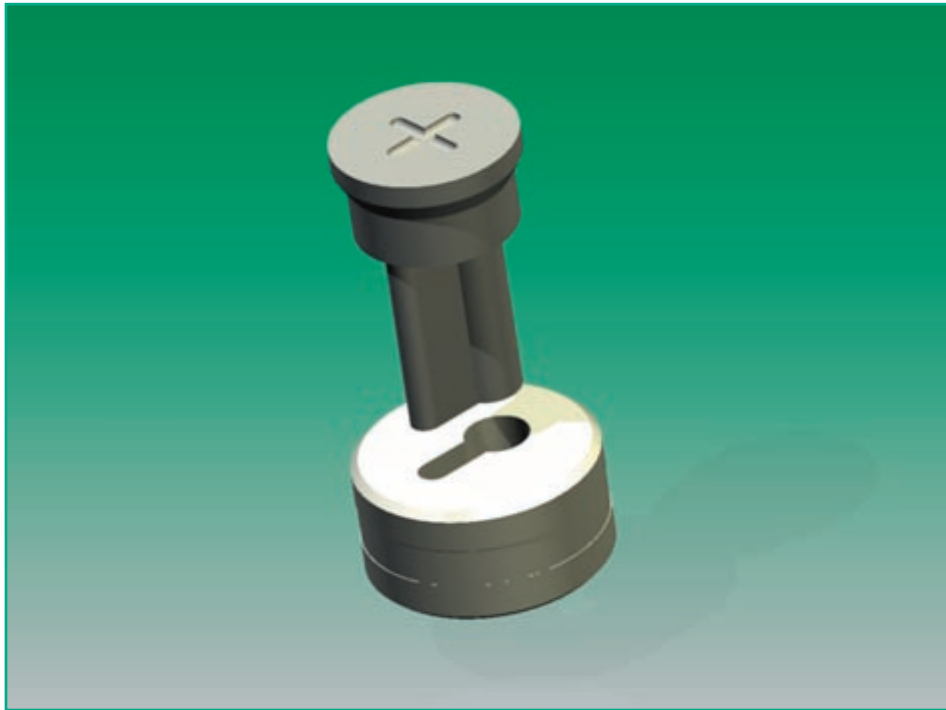

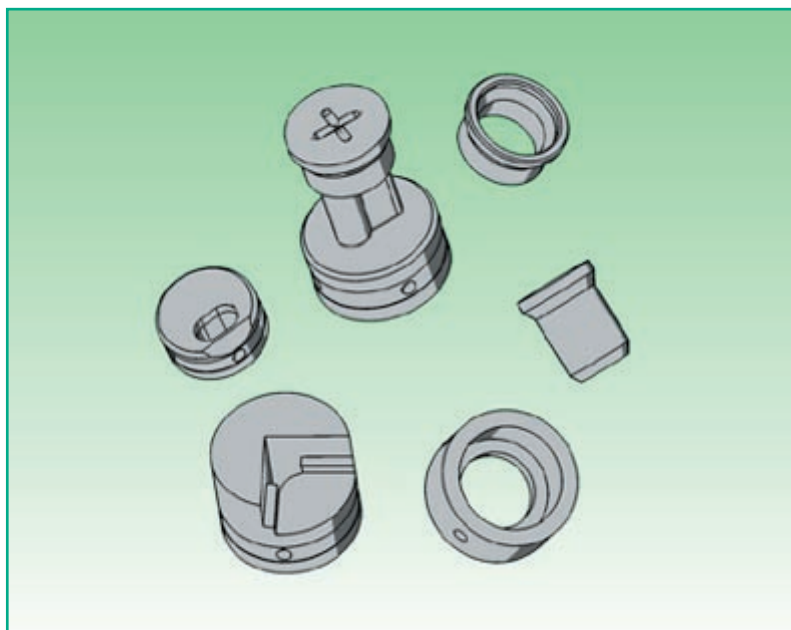

Schülpe
Werkzeug- und Maschinenfabrik GmbH

Im Gewerbegebiet 13
D-26817 Rhaderfehn
Telefon: +49 (0)4952 - 8 95 44 - 0
Telefax: +49 (0)4952 - 8 95 44 - 19
info@schuelpke.de
www.schuelpke.de